

Appendix G: Jess Ranch Composting Facility Traffic Study



HEXAGON TRANSPORTATION CONSULTANTS, INC.



Jess Ranch Composting Facility

Transportation Impact Analysis



Prepared for:

Alameda County



November 26, 2018



Hexagon Office: 7901 Stoneridge Drive, Suite 202
Pleasanton, California 94588
Hexagon Job Number: 15TD02
Phone: 925.225.1439

San Jose • Gilroy • Pleasanton • Phoenix

www.hextrans.com

Areawide Circulation Plans Corridor Studies Pavement Delineation Plans Traffic Handling Plans Impact Fees Interchange Analysis Parking
Transportation Planning Traffic Calming Traffic Control Plans Traffic Simulation Traffic Impact Analysis Traffic Signal Design Travel Demand Forecasting

Table of Contents

Executive Summary	ii
1. Introduction.....	1
2. Existing Conditions.....	9
3. Project Impacts and Mitigation Measures	15
4. Cumulative Conditions	20
5. Other Transportation Issues.....	24

Appendices

- Appendix A: Traffic Counts
- Appendix B: Level of Service Calculations
- Appendix C: Signal Warrant Analysis

List of Tables

Table ES- 1 Intersection Level of Service Summary	v
Table ES- 2 Near Term Project Freeway Segment Level of Service Summary	vi
Table ES- 3 Cumulative Freeway Segment Level of Service Summary	vii
Table 1 Unsignalized Intersection Level of Service Definitions	6
Table 2 Signalized Intersection Level of Service Definitions Based on Average Delay	7
Table 3 Freeway Level of Service Definitions Based on Volume-to-Capacity Ratio (V/C).....	8
Table 4 Existing Intersection Levels of Service	13
Table 5 Existing Freeway Levels of Service	13
Table 6 Project Daily Trip Estimates	16
Table 7 Project Trip Generation	17
Table 8 Project Intersection Levels of Service	18
Table 9 Existing Plus Project Freeway Levels of Service	18
Table 10 Cumulative Intersection Levels of Service	21
Table 11 Cumulative Freeway Levels of Service.....	23

List of Figures

Figure 1 Site Location and Study Intersections.....	2
Figure 2 Existing Lane Configurations	11
Figure 3 Existing Traffic Volumes.....	12
Figure 4 Project Trip Distribution & Assignment	19
Figure 5 Cumulative No Project Traffic Volumes	22
Figure 6 Site Plan	27

Executive Summary

This report presents the results of the transportation impact analysis (TIA) conducted for the proposed Jess Ranch composting facility in unincorporated Alameda County. The project is located near Grant Line Road south of the I-580/Grant Line Road interchange. Access to the project site would be provided via Grant Line Road at Jess Ranch Road.

The potential impacts of the project were evaluated in accordance with the standards set forth by Alameda County. The study included an analysis of AM and PM peak-hour traffic conditions for two unsignalized intersections and two freeway segments.

Project Traffic Estimates

Project trip generation was estimated from data provided by the project applicant regarding the number of employees, visitors and the number of truck haul trips. According to information provided by the applicant, the proposed compost facility will generate approximately 204 daily truck trips (total of inbound and outbound). All of these trips are expected to occur outside of the peak hours; no trucks will be allowed during the morning peak hours between 7:00 AM and 9:00 AM and during the evening peak hours between 4:00 PM and 6:00 PM. The project would employ 12 workers onsite spread over three different time shifts. Approximately 5 visitors are expected to arrive per day. Although the project is not likely to generate any trips during the AM and PM peak commute hours, for the purposes of California Environmental Quality Act (CEQA), a conservative project trip generation estimate was considered by assuming that most employees would have at least one trip end (inbound or outbound) during one of the peak hours and all trips made by visitors were assumed to occur during the peak commute hours. The proposed project is expected to generate a total of 15 new trips during the AM peak hour and 17 new trips during the PM peak hour.

Intersection Levels of Service

Table ES-1 summarizes the results of the study intersection level of service analysis under existing, existing plus project, and cumulative conditions. The analysis concluded that the number of projected project trips would not cause significant impacts at any of the study intersections.

Freeway Segment Level of Service Analysis

The results of the freeway level of service analysis show that the project would not cause a significant increase in traffic volumes (more than one percent of freeway capacity) on any of the study freeway segments under near term project or cumulative conditions. Tables ES-2 and ES-3 summarize these results, respectively. Thus, the project would not cause any significant impacts to nearby freeway segments.

Other Transportation Issues

A review of other transportation issues such as bike, pedestrian and transit facilities, site access and circulation, and parking supply produced several recommendations for the proposed project. These are summarized below.

- Prior to final design, County staff should review the design of the private access roadway to insure it would provide adequate width to accommodate simultaneous passing trucks in opposite directions. The pavement section should be sufficient to accommodate the large number of heavy vehicles to and from the site. Failure to provide a sufficient pavement section could lead to poor traction on the private roadway, thereby decreasing roadway safety.
- Landscaping and equipment are not shown on the current plan. It is recommended that, near all loading areas and intersections, sight distance triangles be maintained so that trucks and passenger vehicles have an unobstructed view of oncoming traffic. In addition, the project site plan should be reviewed by the County staff to insure all truck movements are permissible on site.
- Parking is not shown on the current plan. The applicant should provide a sufficient number of parking spaces to accommodate employees onsite. In the publication *Parking Generation, 3rd Edition*, by ITE, the 85th percentile parking demand for light industrial uses is 0.81 spaces per employee. However, the project area contains no transit service and the distance from residential uses makes access via biking or walking impractical. Based on the number of employees and visitors anticipated, we recommend that one parking space be provided for each employee, plus five additional spaces for visitors or deliveries.

**Table ES- 1
Intersection Level of Service Summary**

	Peak Hour	Count Date	Existing		Project			Cumulative				
								Without Project		With Project		
			Avg. Delay	LOS	Avg. Delay	LOS	Incr. In Delay	Avg. Delay	LOS	Avg. Delay	LOS	Incr. In Delay
Grant Line Road and I-580 EB	AM	10/09/18	8.6 (9.7)	A(A)	8.4 (9.6)	A(A)	-0.2	18.6	B	18.7	B	0.1
	PM	10/09/18	133.4 (373.1)	F(F)	133.5 (374.7)	F(F)	0.1	39.0	D	40.0	D	1.0
Grant Line Road and I-580 WB	AM	10/09/18	34.3 (60.6)	D(F)	36.1 (63.7)	E(F)	1.8	27.1	C	27.2	C	0.1
	PM	10/09/18	0.9 (10.5)	A(B)	0.9 (10.6)	A(B)	0.0	19.5	B	20.3	C	0.8

Notes:

1. The average delay and the delay for the worst approach is shown (in parenthesis) for the unsignalized intersections.
2. Both intersections were analyzed as signalized under cumulative conditions.

**Table ES- 2
Near Term Project Freeway Segment Level of Service Summary**

Freeway	Segment	Direction	Peak Hour	# of Lanes	Ave. Speed /a/	LOS	No Project		Project	
							Existing Volume/b/	Project Trips	V/C Increase	Impact?
I-580	North Flynn Road to Grant Line Road	EB	AM	4	69.2	A	2,875	7	0.001	NO
		EB	PM	4	33.7	E	9,070	3	0.000	NO
I-580	Grant Line Road to I-205	EB	AM	4	66.8	A	2,854	1	0.000	NO
		EB	PM	4	58.8	B	9,345	6	0.001	NO
I-580	I-205 to Grant Line Road	WB	AM	5	19.2	F	9,525	5	0.000	NO
		WB	PM	5	69.3	A	3,631	1	0.000	NO
I-580	Grant Line Road to North Flynn Road	WB	AM	4	33.8	E	9,211	2	0.000	NO
		WB	PM	4	66.8	A	3,676	7	0.001	NO

/a/ Alameda County CMP 2018 Monitoring Report, vehicle speeds.
/b/ Based on counts conducted on 10/9/2018.

**Table ES- 3
Cumulative Freeway Segment Level of Service Summary**

Freeway	Segment	Direction	Peak Hour	No Project		Project			
				Cumulative Volume	LOS	Project Trips	LOS	V/C Increase	Impact?
I-580	North Flynn Road to Grant Line Road	EB	AM	5,050	C	7	C	0.001	NO
		EB	PM	14,199	F	3	F	0.000	NO
I-580	Grant Line Road to I-205	EB	AM	4,880	C	1	C	0.000	NO
		EB	PM	12,908	F	6	F	0.001	NO
I-580	I-205 to Grant Line Road	WB	AM	13,372	F	5	F	0.000	NO
		WB	PM	6,103	C	1	C	0.000	NO
I-580	Grant Line Road to North Flynn Road	WB	AM	14,469	F	2	F	0.000	NO
		WB	PM	6,402	D	7	D	0.001	NO

1. Introduction

This report presents the results of the transportation impact analysis (TIA) conducted for the proposed Jess Ranch composting facility in unincorporated Alameda County. The project is located near Grant Line Road south of the I-580/Grant Line Road interchange. Access to the project site would be provided via Grant Line Road at Jess Ranch Road. The project site location and study intersections are shown on Figure 1.

Scope of Study

The potential impacts of the project were evaluated in accordance with the standards set forth by the lead agency for this study, which is Alameda County. The study included an analysis of AM and PM peak-hour traffic conditions for two unsignalized intersections and two freeway segments. These are listed below.

Study Intersections

1. Grant Line Road and I-580 Eastbound Ramps
2. Grant Line Road and I-580 Westbound Ramps

Study Freeway Segments

1. I-580, west of Grant Line Road (eastbound and westbound directions)
2. I-580, east of Grant Line Road (eastbound and westbound directions)

Traffic conditions at these locations were analyzed for the weekday AM and PM peak hours. The weekday AM peak hour of traffic is generally between 7:00 and 9:00 AM, and the weekday PM peak hour is typically between 4:00 and 6:00 PM. It is during these periods that the most congested traffic conditions occur on a typical weekday. Traffic conditions were evaluated for the following scenarios:

- Scenario 1: *Existing Conditions*. Existing conditions were represented by existing peak-hour traffic volumes on the existing roadway network. Existing traffic volumes were obtained from recent traffic counts conducted in October 2018 and included in Appendix A.
- Scenario 2: *Existing Plus Project Conditions*. Existing Conditions represent near term baseline conditions. Traffic volumes with the project (hereafter called *project traffic volumes*) were estimated by adding to the existing traffic volumes the trips associated with the proposed project. Project conditions were evaluated relative to existing conditions in order to determine potential project impacts.

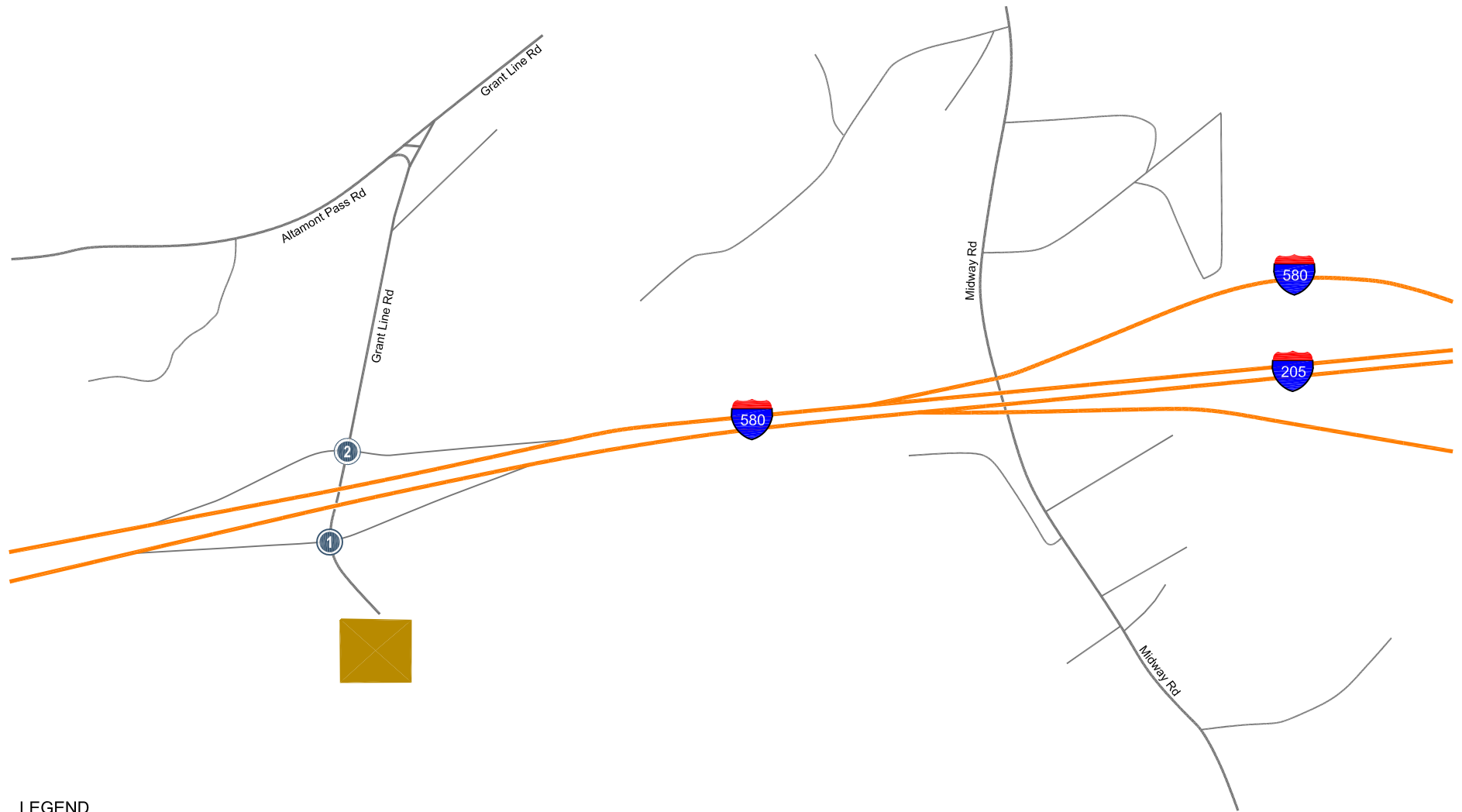

LEGEND



-  = Project Site Location
-  = Study Intersection

Figure 1
Site Location and Study Intersections

- Scenario 3: *Cumulative without Project Conditions.* Cumulative without project conditions represent long-term future traffic conditions. Cumulative without project conditions were estimated by adding traffic from the Sand Hill Wind Project and 10 Grant Line Road Service Station project to the 2025 College Park at Mountain House Specific Plan III Draft EIR traffic volumes at the study locations.
- Scenario 4: *Cumulative with Project Conditions.* Cumulative with project conditions were estimated by adding project traffic to the cumulative without project conditions. Cumulative with project conditions were evaluated relative to cumulative without project conditions in order to determine potential project impacts.

Methodology

This section presents the methods used to determine the traffic conditions for each scenario described above. It includes descriptions of the data requirements, the analysis methodologies, the applicable level of service standards, and the definitions of significant impacts.

Data Requirements

The data required for the analysis were obtained from recent traffic counts, field observations, and published information from various transportation agencies. The following data were collected from these sources:

- existing traffic volumes
- lane configurations
- signal timing and phasing (for signalized intersections)
- approved and pending developments (size, use, and location)

Regulatory Setting

The following is a summary of State, regional and County regulations that apply within the study area. Highways fall under the jurisdiction of Caltrans, while most roads within the study area are under the jurisdiction of Alameda County.

State Regulations

Caltrans responsibilities include the planning, design, construction and maintenance of interstate freeways as well as state highways. Within this study area, I-205 and I-580 fall under the department's jurisdiction. Caltrans' *Guide for the Preparation of Traffic Impact Studies* (December, 2002), identifies the information that Caltrans requires in evaluating the effect of local development and land use changes on state highway facilities.

Metropolitan Transportation Commission (MTC)

The MTC is the transportation planning, coordinating and financing agency for the San Francisco Bay Area. The MTC functions as both the state-mandated regional transportation planning agency and the federally-mandated metropolitan planning organization (MPO) for the region. As such, it is responsible for regularly updating the Regional Transportation Plan, a comprehensive blueprint for the development of transportation facilities within the region. The Commission also screens requests from local agencies for state and federal grants for transportation projects to determine their compatibility with the plan.

Transportation 2035, the most recent version of the long-range plan, was adopted in April, 2009. MTC is also responsible for updating and prioritizing projects within the Regional Transportation Improvement Program (RTIP).

Alameda County Transportation Commission (ACTC)

The mission of ACTC is to plan, fund and deliver transportation programs and projects that expand access and improve mobility to foster a vibrant and livable Alameda County. The ACTC coordinates countywide transportation planning efforts; programs local, regional, state and federal funding; and delivers projects and

programs including those approved by voters in Alameda County transportation expenditure plans for Measure B, Measure BB and the Vehicle Registration Fee. ACTC was created in July 2010 by the merger of the Alameda County Congestion Management Agency (ACCMA) and the Alameda County Transportation Improvement Authority (ACTIA), to streamline operations, eliminate redundancies and save taxpayers dollars. As a result of the merger, ACTC is able to implement more cost-effective methods for planning, funding and delivering programs and projects that benefit Alameda County residents and businesses. The project site is part of ACTC's East County planning area.

Congestion Management Agency (CMA)

The Alameda County Congestion Management Agency manages the County's blueprint to reduce congestion and improve air quality. In this role, the CMA makes decisions on what local projects can utilize federal and state funding. The CMA prepares, adopts and updates the County's Congestion Management Program (CMP) and the Countywide Transportation Plan, last updated in 2017. The project site is part of the CMA's Planning Area Four.

Tri-Valley Transportation Council (TVTC)

The TVTC includes the Cities of San Ramon, Dublin, Pleasanton, Livermore, the Town of Danville, and unincorporated areas of Alameda and Contra Costa Counties. Founded in 1991, the TVTC completed the *Tri-Valley Transportation Plan/Action Plan for Routes of Regional Significance* in 2017. The Plan establishes shared traffic service objectives and presents a list of transportation improvement projects to ease regional traffic congestion. The Tri-Valley Transportation Development Fee on new developments will fund these improvements.

Local Regulations

The Alameda County Community Development Agency's *East County Area Plan* guides future development within the project area. The plan was adopted in 1994 and modified in 2000.

The *Transportation Systems* chapter of the plan identifies the overarching goal of providing a multi-modal transportation system that safely moves both people and goods. Policies 183, 184 and 185 state, respectively that the County will work to minimize congestion levels, Average Daily Traffic (ADT) trips and peak hour trips within the area. Policy 194 requires the preparation of a Traffic Impact Study for all major projects to determine compliance with LOS standards.

Level of Service Standards and Analysis Methodologies

Traffic conditions at the study intersections were evaluated using level of service (LOS). *Level of Service* is a qualitative description of operating conditions ranging from LOS A, or free-flow conditions with little or no delay, to LOS F, or jammed conditions with excessive delays. The various analysis methods are described below. All of the study intersections are located in unincorporated Alameda County and are subject to County Level of Service standards. Intersections in Alameda County have a LOS standard of D, with LOS E being acceptable on CMP-designated roadways.

Significance criteria are used to define what constitutes an impact. For this analysis, project impacts were based on Alameda County Level of Service standards. The project is said to create a significant adverse impact on traffic conditions if for any peak hour:

- At a signalized intersection, the level of service at the intersection degrades from an acceptable LOS D to an unacceptable LOS E or LOS F (and from an acceptable LOS E to an unacceptable LOS F for CMP designated facilities) with the addition of project traffic.
- At an unsignalized intersection, when project traffic is added, the level of service at the intersection degrades from an acceptable LOS D to LOS E or LOS F (and acceptable LOS E to LOS F for CMP designated facilities) **AND** a peak hour traffic signal warrant would be satisfied.
- At freeway segments, Caltrans maintains that a LOS C or D is desirable. However, the Alameda County Congestion Management Program LOS standard for routes of regional significance (including freeways) is LOS E. Therefore, an impact would be created if the LOS on the segment degrades from an acceptable LOS E or better under no project conditions to an unacceptable LOS

- F with the addition of project traffic.
- If the intersection or segment is already operating below its level of service standard, then an impact by the project would be created if the project increases traffic “substantially” relative to the existing capacity of the facility. For this analysis, a substantial increase was defined as (1) four seconds of delay at an intersection or (2) a V/C increase of 0.01 at a freeway segment.

A significant impact is said to be satisfactorily mitigated when measures are implemented that would restore intersection levels of service to better than no project conditions. Since the two study intersections are interchanges with I-580, which is a CMP designated Tier 1 facility, they were evaluated with LOS E being the acceptable standard.

Intersections

Level of service at unsignalized and signalized intersections in Alameda County are based on the *Highway Capacity Manual* method. The software called TRAFFIX was used to apply the HCM operations method for evaluation of conditions at intersections. The HCM method evaluates intersection operations on the basis of average control delay time for all vehicles at the intersection. *Control delay* is the amount of delay that is attributed to the particular traffic control device at the intersection, and includes initial deceleration delay, queue move-up time, stopped delay, and final acceleration delay. The correlation between average delay and level of service is shown in Table 1 for unsignalized intersections and Table 2 for signalized intersections.

Intersection Queuing

The operations analysis is based on vehicle queuing for high-demand movements at intersections. Vehicle queues were estimated using a Poisson probability distribution, which estimates the probability of “n” vehicles for a vehicle movement using the following formula:

$$P(x=n) = \frac{\lambda^n e^{-\lambda}}{n!}$$

Where:

P (x=n) = probability of “n” vehicles in queue per lane

n = number of vehicles in the queue per lane

λ = Average number of vehicles in the queue per lane (vehicles per hour per lane/signal cycles per hour)

The basis of the analysis is as follows: (1) the Poisson probability distribution is used to estimate the 95th percentile maximum number of queued vehicles per signal cycle for a particular movement; (2) the estimated maximum number of vehicles in the queue is translated into a queue length, assuming 25 feet per vehicle; and (3) the estimated maximum queue length is compared to the existing or planned available storage capacity for the movement.

Freeway Segments

Alameda CTC uses commercial speed data and floating car surveys to collect travel time information by measuring the average speed of traffic over a specific length of roadway. The average speed is then classified from LOS A (best) to LOS F (worst). LOS A represents the best travel conditions from the driver’s perspective where roadways are uncongested, and LOS F represents congested conditions or deteriorated traffic flows. These standards are based on the Highway Capacity Manual (HCM) 1985 and shown in Table 3. Because of the difficulty involved with estimating the speeds for future conditions (for example with the addition of project trips), project’s impact to the freeway segments was estimated based on a volume to capacity ratio. A capacity of 2,000 vehicles per hour per lane (vphpl) was used for mixed-flow lane segments. The LOS standard for study freeway segments is LOS E. An impact by the project would be created if the LOS for a freeway segment degrades from an acceptable LOS E or better to unacceptable LOS F with the addition of project traffic. If a study segment is already operating below its level of service standard, then an impact by the project would be created if the project increases traffic substantially relative to the existing capacity of the facility. Most

jurisdictions consider a project contribution to be significant when its traffic constitutes between 1% and 3% of the capacity of a freeway segment. For this study, it is assumed that an impact would be created if the project contributes traffic to the freeway segment and increases the volume to capacity ratio by more than 0.01.

Table 1
Unsignalized Intersection Level of Service Definitions

Level of Service	Description	Average Delay Per Vehicle (Sec.)
A	Little or no traffic delay	10.0 or less
B	Short traffic delays	10.1 to 15.0
C	Average traffic delays	15.1 to 25.0
D	Long traffic delays	25.1 to 35.0
E	Very long traffic delays	35.1 to 50.0
F	Extreme traffic delays	greater than 50.0

Source: Transportation Research Board, *2000 Highway Capacity Manual* (Washington, D.C., 2000) p17-2.

Report Organization

The remainder of this report is divided into five chapters. Chapter 2 describes the existing roadway network, transit service, and existing bicycle and pedestrian facilities. Chapter 3 details near-term project conditions, the method used to estimate project traffic, the project's impact on the transportation system, and the recommended mitigation measures, as applicable. Chapter 4 describes far-term cumulative conditions. Chapter 5 discusses various other transportations issues such as bicycle and pedestrian facilities, transit service, and site plan review, and on-site parking. Chapter 6 presents the conclusions of the traffic impact analysis.

Table 2
Signalized Intersection Level of Service Definitions Based on Average Delay

Level of Service	Description	Average Total Delay Per Vehicle (Sec.)
A	Signalized progression is extremely favorable. Most vehicles arrive during the green phase and do not stop at all. Short cycle lengths may also contribute to the very low vehicle delay.	10.0 or less
B	Operations characterized by good signal progression and/or short cycle lengths. More vehicles stop than with LOS A, causing higher levels of average vehicle delay.	10.1 to 20.0
C	Higher delays may result from fair signal progression and/or longer cycle lengths. Individual cycle failures may begin to appear at this level. The number of vehicles stopping is significant, though may still pass through the intersection without stopping.	20.1 to 35.0
D	The influence of congestion becomes more noticeable. Longer delays may result from some combination of unfavorable signal progression, long cycle lengths, or high volume-to-capacity (V/C) ratios. Many vehicles stop and individual cycle failures are noticeable	35.1 to 55.0
E	This is considered to be the limit of acceptable delay. These high delay values generally indicate poor signal progression, long cycle lengths, and high volume-to-capacity (V/C) ratios. Individual cycle failures occur frequently.	55.1 to 80.0
F	This level of delay is considered unacceptable by most drivers. This condition often occurs with oversaturation, that is, when arrival flow rates exceed the capacity of the intersection. Poor progression and long cycle lengths may also be major contributing causes of such delay levels.	Greater than 80.0

Source: Transportation Research Board, *2000 Highway Capacity Manual* (Washington, D.C., 2000) p10-16

Table 3
Freeway Level of Service Definitions Based on Travel Speed

Level of Service	Description	Average Travel Speed (mph)	Volume-To-Capacity Ratio	Maximum Traffic Volume (vehicles/hour/lane)
A	Average operating speeds at the free-flow speed generally prevail. Vehicles are almost completely unimpeded in their ability to maneuver within the traffic stream.	>=60	0.35	700
B	Speeds at the free-flow speed are generally maintained. The ability to maneuver within the traffic stream is only slightly restricted, and the general level of physical and psychological comfort provided to drivers is still high.	>=55	0.58	1000
C	Speeds at or near the free-flow speed of the freeway prevail. Freedom to maneuver within the traffic stream is noticeably restricted, and lane changes require more vigilance on the part of the driver.	>=49	0.75	1500
D	Speeds begin to decline slightly with increased flows at this level. Freedom to maneuver within the traffic stream is more noticeably limited, and the driver experiences reduced physical and psychological comfort levels.	>=41	0.9	1800
E	At this level, the freeway operates at or near capacity. Operations in this level are volatile, because there are virtually no usable gaps in the traffic stream, leaving little room to maneuver within the traffic stream.	>=30	1	2000
F	Vehicular flow breakdowns occur. Large queues form behind breakdown points.	<30	Variable	-

Source: Highway Capacity Manual (HCM) 1985

2. Existing Conditions

This chapter describes the existing conditions for all of the major transportation facilities in the vicinity of the site, including the roadway network, transit service, and bicycle and pedestrian facilities. For this analysis, it should be noted that existing conditions were assumed to be the same as near-term baseline conditions.

Existing Roadway Network

Regional access to the project study area is provided by I-580:

- *I-580* is an east/west freeway, with four mixed flow lanes in the eastbound direction and five mixed flow lanes in the westbound direction in the proximity of the West Grant Line Road interchange. The fifth lane on I-580 westbound terminates approximately 1 mile west of the Grant Line Road interchange. I-580 provides regional access from Marin County and the East Bay cities to San Joaquin County, where it merges with I-5. Access to the project study area is provided via its interchange with West Grant Line Road.

Local access to the project area is provided by West Grant Line Road:

- *West Grant Line Road* is primarily a north/south roadway in the vicinity of the project site. The road has two lanes and extends from West Byron Road to I-580. South of I-580, West Grant Line Road becomes Jess Ranch Road.

Existing Bicycle, Pedestrian, and Transit Facilities

The study area is rural in character with few other land uses nearby and virtually no pedestrian activity. According to the Alameda Countywide Bicycle Plan, there are no bike facilities near the study area. In addition, field observations revealed there are no pedestrian facilities (sidewalks or crosswalks) in the project area.

No access to transit is currently provided near the project site. Both the San Joaquin Regional Transit District and Tri Delta Transit operate bus routes on I-580 through the project area, but do not have bus stops near the project site. The closest access to the BART system, which provides service to San Francisco and many locations in the East Bay, is at the Dublin-Pleasanton Station. This is located about 18 miles west of the project site. The closest access to the Altamont Commuter Express, with service to San Jose and Stockton, is at the Vasco Road Station in Livermore, nine miles west of the project site.

Existing Intersection Lane Configurations

The existing lane configurations at the study intersections were determined by observations in the field. The existing intersection lane configurations are shown on Figure 2.

Existing Traffic Volumes

Existing peak-hour vehicle traffic volumes were obtained from new turning movement counts conducted in October 2018. The existing volumes are shown on Figure 3. The existing peak-hour intersection turning movement counts are shown in Appendix A.

Existing Intersection Levels of Service

The results of the level of service analysis under existing conditions are summarized in Table 4.



Grant Line Road and I-580 EB – The results show that the unsignalized intersection of West Grant Line Road and the eastbound I-580 ramps currently operates at an acceptable LOS A during the AM peak hour but at an unacceptable LOS F during the PM peak hour period. This unacceptable level of service during the PM peak hour period is attributed to the high volume of traffic (238 PM peak hour trips) coming from the off-ramp that have to find gaps in the uncontrolled southbound traffic on West Grant Line Road. However, based on field observations conducted during the PM peak hour period, this intersection appeared to operate without any significant traffic issues. Occasionally, a vehicular queue of 5 to 6 vehicles were observed on the I-580 eastbound off-ramp waiting to find gaps in the uncontrolled southbound traffic flow on West Grant Line Road. Field observations did not indicate any spill back from the off-ramp extending onto the freeway mainline.

The level of service analysis at this intersection was supplemented with an assessment of the need for potential signalization of this intersection. This assessment was made on the basis of signal warrant criteria adopted by Caltrans. For this study, the potential for signalization was assessed on the basis of the peak-hour traffic signal warrant, Warrant #3, volume criteria described in the *California Manual on Uniform Traffic Control Devices* (CA MUTCD). This method provides an indication of whether traffic conditions and peak-hour traffic levels are, or would be, sufficient to justify installation of a traffic signal. The analysis showed that the peak hour volumes are sufficiently high to satisfy the peak hour volume warrant during the PM peak hour period under existing conditions. However, based on field observations, a traffic signal is not recommended at this intersection as this intersection was observed to operate without any significant operational issues during either of the peak hours. It was observed that traffic on the uncontrolled approach on Grant Line Road arrived in platoons and provided adequate gaps for traffic on the eastbound off-ramp to make left-turn onto northbound Grant Line Road.

Grant Line Road and I-580 WB - The results show that the unsignalized intersection of West Grant Line Road and the westbound I-580 ramps currently operates at an acceptable level of service D or better during both the AM and PM peak hour durations. During the AM peak hour, the analysis shows that the intersection operates with an unacceptable LOS F for the worst approach on the minor street, which is the shared left-through movement on the I-580 westbound off-ramp. Field observations and turning movement counts show that approximately 50 percent of the traffic (400 vehicles) exiting the off-ramp re-entered the freeway mainline in order to bypass some of the traffic congestion on I-580. As a result of the diverted traffic from the freeway, occasionally 5 to 6 vehicles were observed to queue on the off-ramp. Field observations did not indicate any spill backs onto the freeway mainline and did not show any significant operational issue at this intersection.

The level of service analysis at this intersection was supplemented with an assessment of the need for potential signalization of this intersection. The analysis shows that, with the diverted traffic from the freeway, the peak hour volumes are sufficiently high to satisfy the peak hour volume warrant during the AM peak hour under existing conditions. However, based on field observations, a traffic signal is not recommended as no significant operational issues were observed at this intersection during either of the peak hours. Also, a

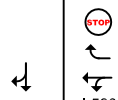
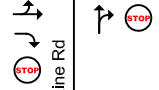
Jess Ranch

<p>1</p>  <p>I-580 EB Off-Ramp</p>	<p>2</p>  <p>I-580 WB Off-Ramp</p>
 <p>Grant Line Rd</p>	 <p>Grant Line Rd</p>

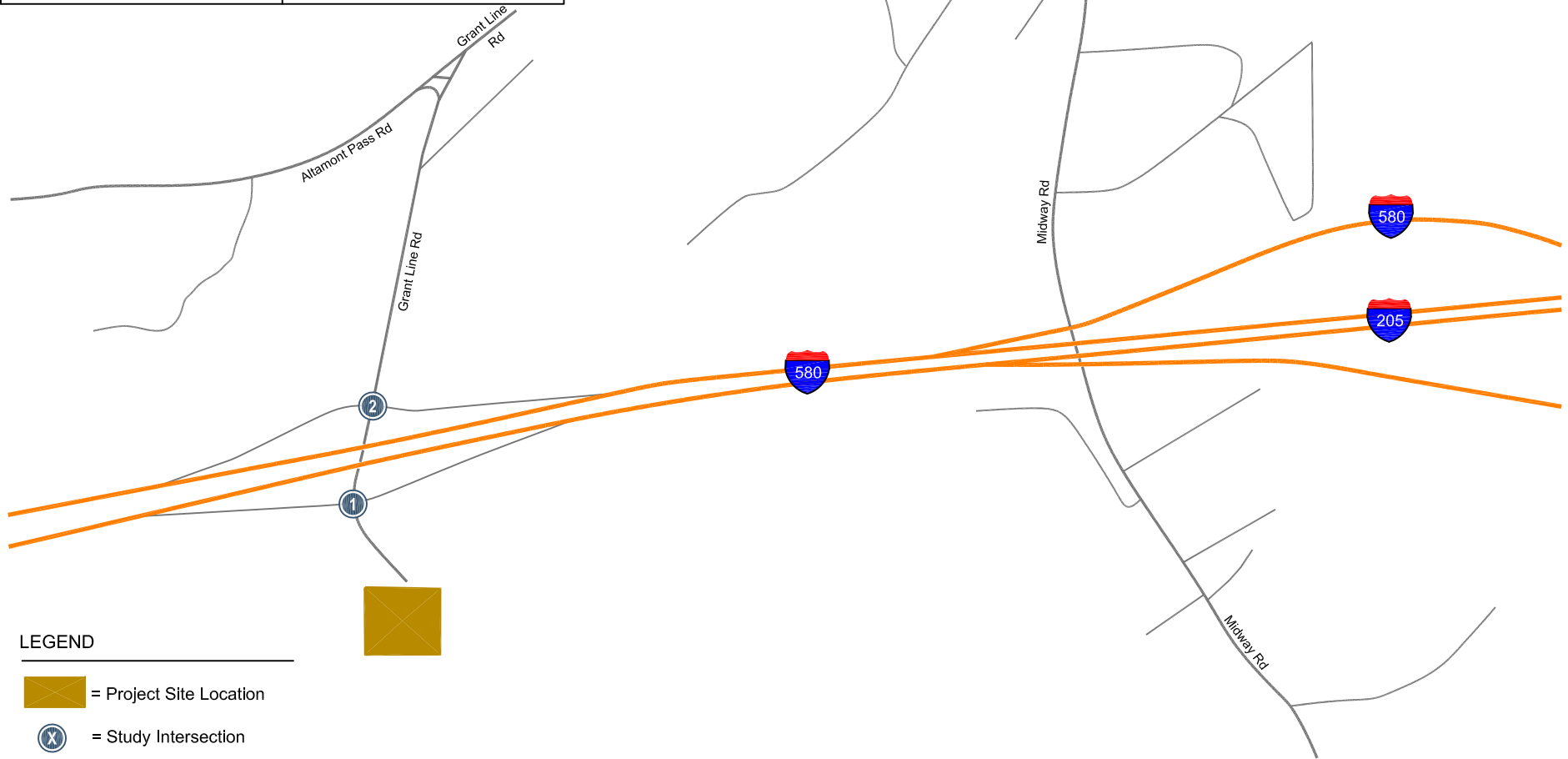

LEGEND



-  = Project Site Location
-  = Study Intersection
-  = Stop Sign

Figure 2
Existing Lane Configurations

Jess Ranch

<p>1</p> <p>↓ 2(7) ↪ 54(493)</p> <p>I-580 EB Off-Ramp</p>	<p>2</p> <p>↪ 436(68) ↑ 414(2) ↩ 10(5) ↩ 540(118) ↓ 46(495)</p> <p>I-580 WB Off-Ramp</p>
<p>↪ 75(238) ↩ 6(22) ↩ 1(21)</p> <p>Grant Line Rd</p>	<p>↪ 1(9) ↩ 1(41)</p> <p>Grant Line Rd</p> <p>↩ 6(2) ↪ 70(245)</p> <p>Grant Line Rd</p>

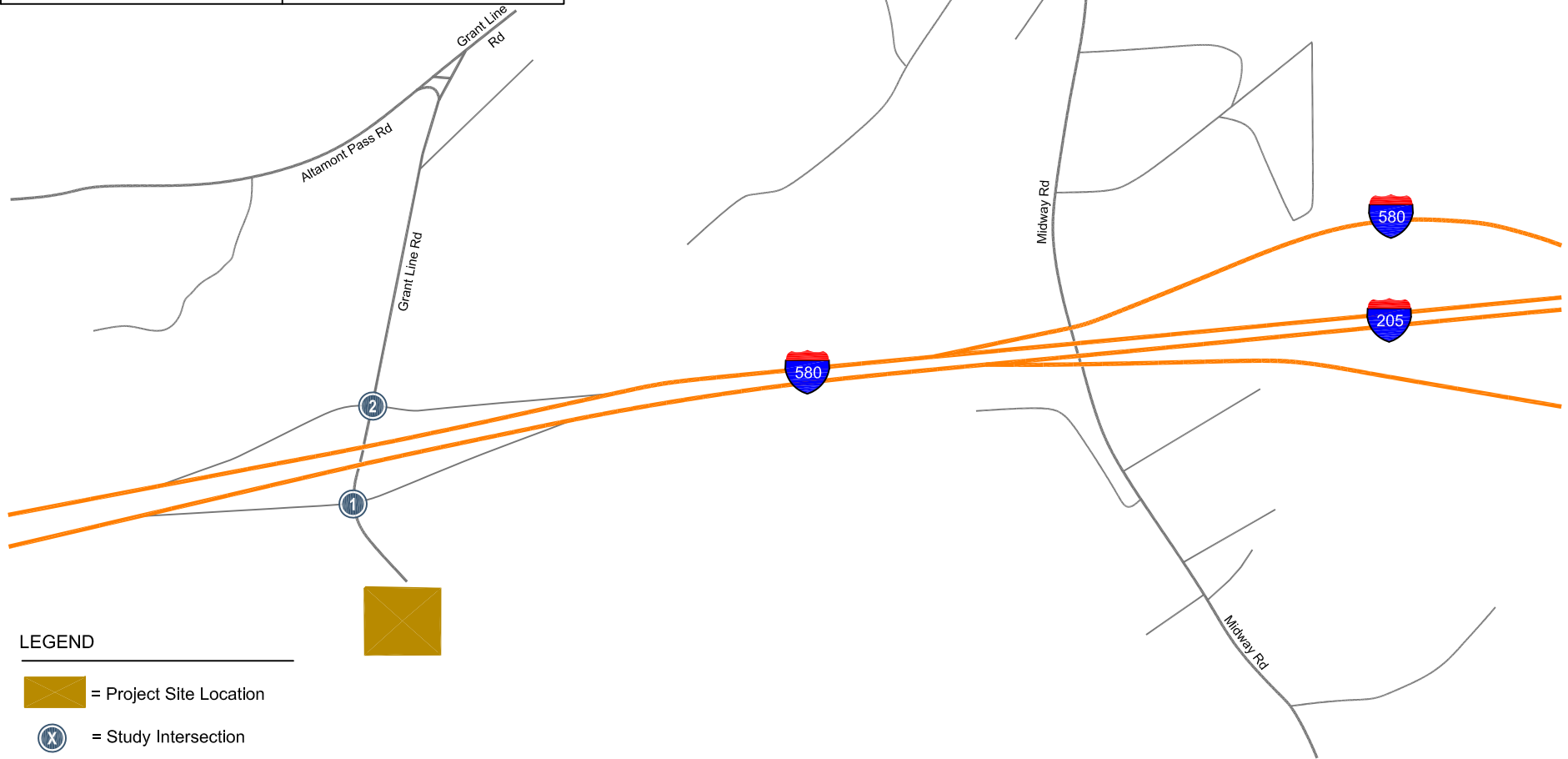

LEGEND

= Project Site Location

= Study Intersection

XX(X) = AM(PM) Peak-Hour Traffic Volumes

Figure 3
Existing Traffic Volumes

traffic signal at this intersection could potentially encourage more traffic to divert from the freeway and use this intersection in order to by-pass some of the freeway congestion on I-580.

The level of service calculation sheets are included in Appendix B.

**Table 4
Existing Intersection Levels of Service**

Intersection	Peak Hour	Count Date	Avg. Delay	LOS
Grant Line Road and I-580 EB	AM	10/09/18	8.6 (9.7)	A(A)
	PM	10/09/18	133.4 (373.1)	F(F)
Grant Line Road and I-580 WB	AM	10/09/18	34.3 (60.6)	D(F)
	PM	10/09/18	0.9 (10.5)	A(B)

Notes:
1. The average delay and the delay for the worst approach is shown (in parenthesis) for unsignalized intersections.

Existing Freeway Levels of Service

Traffic volumes for the study freeway segments were obtained from freeway mainline counts conducted in October 2018 by Hexagon Transportation Consultants. Vehicular speeds on the freeway mainline were obtained from the Alameda County CMP 2018 Monitoring Report, which is the most recent CMP report available. The results of the analysis are summarized in Table 5.

**Table 5
Existing Freeway Levels of Service**

Freeway	Segment	Direction	Peak Hour	Ave. Speed /a/	LOS /a/	Mixed-Flow Lanes	
						# of Lanes /a/	Volume /b/
I-580	North Flynn Road to Grant Line Road	EB	AM	69.2	A	4	2,875
		EB	PM	33.7	E	4	9,070
I-580	Grant Line Road to I-205	EB	AM	66.8	A	4	2,854
		EB	PM	58.8	B	4	9,345
I-580	I-205 to Grant Line Road	WB	AM	19.2	F	5	9,525
		WB	PM	69.3	A	5	3,631
I-580	Grant Line Road to North Flynn Road	WB	AM	33.8	E	4	9,211
		WB	PM	66.8	A	4	3,676

/a/ Alameda County CMP 2018 Monitoring Report, vehicle speeds.
/b/ Based on counts conducted on 10/9/2018. The volume on I-580 WB during the AM peak hour and I-580 EB during the PM peak hour were adjusted to reflect demand volumes.

The results show that all of the study freeway segments currently operate at acceptable levels of service (LOS E or better) during the AM and PM peak hour periods, except for the following segment.

I-580 WB from I-205 to Grant Line Road – The CMP report shows that this segment of the freeway mainline currently operates at an unacceptable LOS F during the AM peak hour. This explains the freeway cut-through traffic through the Grant Line Road interchange as observed in the field.

Other Field Observations

Field observations revealed that at Grant Line Road & I-580 Eastbound Ramps, many vehicles were parked on both sides of the southern leg of Grant Line Road. This area appears to be used as an unofficial park and ride lot.

3.

Near Term Project Impacts and Mitigation

This chapter describes near term project traffic conditions, significant project impacts, and any measures that are needed to mitigate project impacts. Included are estimates of project-generated traffic, project traffic volumes and levels of service, identification of the impacts, and descriptions of the mitigation measures. Project conditions are represented by existing traffic conditions with the addition of traffic generated by the proposed project.

Transportation Network Under Project Conditions

It is assumed in this analysis that the transportation network under near term project conditions would be the same as the existing transportation network.

Project Traffic Estimates

The magnitude of traffic produced by a new development and the locations where that traffic would appear are estimated using a three-step process: (1) trip generation, (2) trip distribution, and (3) trip assignment. In determining project trip generation, the magnitude of traffic entering and exiting the site is estimated for the AM and PM peak hours. As part of the project trip distribution step, an estimate is made of the directions to and from which the project trips would travel. In the project trip assignment step, the project trips are assigned to specific streets and intersections in the study area. These procedures are described further in the following sections.

Trip Generation

Project trip generation was estimated from data provided by the project applicant regarding the number of employees, visitors and the number of truck haul trips. This data is summarized in Table 6. According to information provided by the applicant, the proposed compost facility will generate approximately 204 daily trips (total of inbound and outbound). No trucks will be allowed during the morning peak hours between 7:00 AM and 9:00 AM and during the evening peak hours between 4:00 PM and 6:00 PM. The project would employ 12 workers onsite spread over three different time shifts (eight employees from 7:00 AM to 3:30 PM, two employees from 9:30 AM to 6:00 PM, one employee from 3:30 PM to 12:00 AM and one employee from 12:00 AM to 6:30 AM). Based on these starting and ending time periods, all employee trips would likely be made outside of the AM and PM peak commute periods, unless employees arrive late, 30 minutes after their shift starts or leave late, 30 minutes after their shift ends. Approximately 5 visitors are expected to arrive per day. Based on information provided by the applicant, the visiting hours would be restricted so that no visitor trips would occur during the peak commute hours. Although the project is not likely to generate any trips during the AM and PM peak commute hours, for CEQA purposes, a conservative project trip generation estimate was considered by assuming that most of the employees would have at least one trip end (inbound or outbound)

during one of the peak hours and all trips made by visitors were assumed to occur during the peak commute hours. The trip generation estimates are summarized in Table 7. As shown in the table, the proposed project is expected to generate a total of 15 new trips during the AM peak hour and 17 new trips during the PM peak hour period.

**Table 6
Project Daily Trip Estimates**

Jess Ranch Composting Facility Daily Traffic			
Description	# of Vehicles	Trip Origination	Total Daily Trips
Employee Trips (12 employees)	12		24
Organic Waste Delivery Truck Traffic Trips (from west)	30	580 - West	60
Organic Waste Delivery Truck Traffic Trips (from east)	10	580 - East	20
Compost Product Delivery Trucks (to west)	10	580 - West	20
Compost Product Delivery Trucks (to east)	30	580 - East	60
Water Truck	5	Grantline - North	10
Vistors (from west)	4	580 - West	8
Vistors (from east)	1	580 - East	2
Totals	102		204
Employee Schedule			
1st. Shift (7:00 AM to 3:30 PM)	8		16
2nd. Shift (9:30 AM to 6:00 PM)	2		4
3rd. Shift (3:30 PM to 12:00 AM)	1		2
Watchman (12:00 AM to 6:30 AM)	1		2
Totals	12		24
Truck Schedule			
No Trucks Allowed 7:00 AM to 9:00 AM			
No Trucks Allowed 4:00 PM to 6:00 PM			
Source: Biosolids Recycling, Inc.			

Trip Distribution and Assignment

The trip distribution for peak hour project-generated traffic was estimated based on data supplied by the project applicant. It is anticipated that 60% of the project traffic would have origins and destinations in Alameda County and 40% would have origins and destinations in San Joaquin County. The peak-hour trips generated by the proposed project (the project trips) were added to the street network in accordance with the project trip generation and distribution described above. Figure 4 shows the trip distribution and assignment of project traffic at the study intersections.

Project Traffic Volumes

Project trips, as represented in the above project trip assignment, were added to existing traffic volumes to obtain existing plus project traffic volumes. Existing traffic volumes plus project trips are typically referred to simply as *project traffic volumes*; this is contrasted with the term *project trips*, which is used to signify the traffic that is produced specifically by the project.

**Table 7
Project Trip Generation**

Trip Type	Daily Trips /a/	AM Peak Hour Trips			PM Peak Hour Trips		
		In	Out	Total	In	Out	Total
Trucks /b/	190	0	0	0	0	0	0
Employees, etc /c/	24	10	1	11	1	10	11
Visitors /d/	10	2	2	4	3	3	6
Total	224	12	3	15	4	13	17

Notes:
/a/ Includes total daily trips from site, inbound and outbound
/b/ Consists of waste delivery trucks, compost product delivery trucks and water trucks
/c/ Includes traffic from 12 employees on site. Trip generation based on employee shift timing information provided by Biosolids Recycling, Inc.
/d/ A total of 5 visitors expected on a typical weekday. It was assumed that all visitors would arrive and depart during peak commute periods.

Project Intersection Levels of Service

The results of the intersection level of service analysis under near-term project conditions are summarized in Table 8. The results indicate that the intersection of West Grant Line Road/I-580 westbound ramps would continue to operate at an acceptable level of service (LOS E or better) during both the AM and PM peak hours with the proposed project. The worst approach on the minor street would continue to operate at an unacceptable LOS F during the AM peak hour with the addition of project traffic. The project would add only 5 trips (or one new trip every 12 minutes) to the left-turn movement on the westbound off-ramp during the AM peak hour. This would not create a significant impact to the existing intersection operations.

The intersection of West Grant Line Road/I-580 eastbound ramps would continue to operate at an acceptable LOS E or better during the AM peak hour and at an unacceptable LOS F during the PM peak hour. As discussed under existing conditions, the eastbound approach of the Grant Line Road/I-580 eastbound ramps intersection would continue to operate at an unacceptable LOS F during the PM peak hour. The project would add few trips to this approach; approximately 7 vehicles during the AM peak hour and 3 vehicles during the PM peak hour. The signal warrant analysis showed that this intersection would meet the peak hour volume signal warrant under existing conditions and with the addition of project traffic. However, a traffic signal is not recommended based on field observations of existing conditions during the peak periods. Given the small magnitude of project trips the project would not cause a significant impact at this intersection during either of the peak hours.

Thus, although both study intersections are projected to operate at poor levels of service during one peak hour, the project would not increase traffic substantially relative to the existing capacity of the intersections. For this study, an increase in delay of four seconds or more was considered to be a substantial increase in traffic. The maximum increase in vehicle delay caused by the project under any scenario would be 1.8 seconds. The levels of service calculation sheets are included in Appendix B.

**Table 8
Project Intersection Levels of Service**

Intersection	Peak Hour	Existing		Project		Incr. In Delay
		Avg. Delay	LOS	Avg. Delay	LOS	
Grant Line Road and I-580 EB	AM	8.6 (9.7)	A(A)	8.4 (9.6)	A(A)	-0.2
	PM	133.4 (373.1)	F(F)	133.5 (374.7)	F(F)	0.1
Grant Line Road and I-580 WB	AM	34.3 (60.6)	D(F)	36.1 (63.7)	E(F)	1.8
	PM	0.9 (10.5)	A(B)	0.9 (10.6)	A(B)	0.0

Notes:
1. The average delay and the delay for the worst approach is shown (in parenthesis) for the unsignalized intersections.

Project Freeway Segment Level of Service Analysis

The results of the freeway level of service analysis are summarized in Table 9. The results show that all study freeway segments would operate at acceptable LOS E or better with the addition of project traffic except for I-580 westbound between I-205 and Grant Line Road. This segment would continue to operate at an unacceptable LOS F with the addition of project trips. However, the project would contribute less than 5 trips during the AM peak hour, which would be less than 1% of the freeway's capacity (V/C less than 0.01). Therefore, the project's impact would be less than significant under near term project conditions.

**Table 9
Existing Plus Project Freeway Levels of Service**

Freeway	Segment	Direction	Peak Hour	# of Lanes	Ave. Speed /a/	LOS	No Project		Project	
							Existing Volume/b/	Project Trips	V/C Increase	Impact?
I-580	North Flynn Road to Grant Line Road	EB	AM	4	69.2	A	2,875	7	0.001	NO
		EB	PM	4	33.7	E	9,070	3	0.000	NO
I-580	Grant Line Road to I-205	EB	AM	4	66.8	A	2,854	1	0.000	NO
		EB	PM	4	58.8	B	9,345	6	0.001	NO
I-580	I-205 to Grant Line Road	WB	AM	5	19.2	F	9,525	5	0.000	NO
		WB	PM	5	69.3	A	3,631	1	0.000	NO
I-580	Grant Line Road to North Flynn Road	WB	AM	4	33.8	E	9,211	2	0.000	NO
		WB	PM	4	66.8	A	3,676	7	0.001	NO

/a/ Alameda County CMP 2018 Monitoring Report, vehicle speeds.
/b/ Based on counts conducted on 10/9/2018.

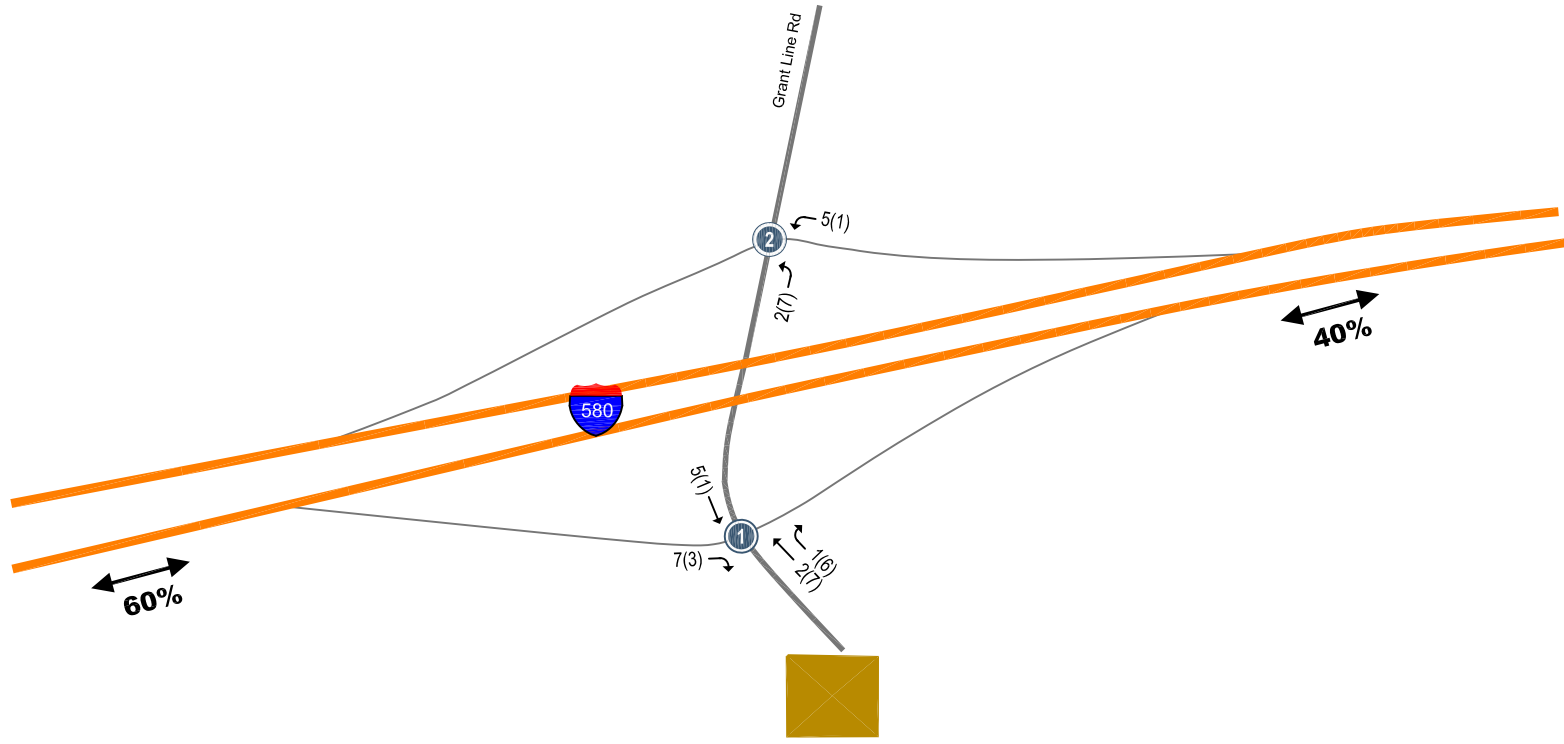

LEGEND

 = Project Site Location

 = Study Intersection

XX(X) = AM(PM) Peak-Hour Trips

Figure 4
Project Trip Distribution and Assignment

4. Cumulative Conditions

This chapter presents a summary of the traffic conditions that would occur under cumulative conditions both with and without the proposed project. For this analysis, cumulative conditions represent future traffic conditions with all approved and pending projects in the project vicinity.

Cumulative Traffic Volumes

Cumulative conditions include vehicle trips associated with pending and approved developments in San Joaquin County and Alameda County. The following approved/pending developments would produce trips in the study area:

- **Mountain House.** 15,700 residential units and 3.5 million square feet of commercial and retail space in western San Joaquin County.
- **Sand Hill Wind Project.** The project would be located within the Alameda County portion of the Altamont Pass Wind Resource Area (APWRA), in eastern Alameda County, bisected by Interstate I-580. Phase 1 (Initial Repower) of the project involves replacement of an estimated 73 existing wind turbines with 40 shrouded wind turbines on approximately 1,000 acres. Construction would intermittently generate traffic during the decommissioning and installation of the wind turbines. Once the turbines are installed and in operation, maintenance needs would be very limited and traffic generation would not differ much from current maintenance traffic levels. Phase 2 of the project would include installation of more wind turbines adjacent to Phase 1. The final EIR was approved in May 2014. Although the Wind Project is expected to generate traffic during the construction phase, the full buildout of the Wind Project is not expected to generate any additional trips. Also, during the construction phase, the Wind Project will schedule construction hours to avoid workers commuting to/from the project parcels and limit truck access to the project parcels during the typical weekday peak commute hours (7 – 9 AM and 4 – 6 PM).
- **10 Grant Line Road Service Station.** This service station is proposed at 10 Grant line Road just south of the interchange of I-580 and Grant Line Road.

Transportation Network Under Cumulative Conditions

The following improvements are programmed in the project vicinity that would affect operations on the study locations:

- Grant Line Road Intersections at I-580.** Traffic signals would be installed at both intersections at the interchange in conjunction with the buildout of the Mountain House development. In addition, additional travel lanes are planned on Grant Line Road at each interchange intersection. These improvements require a future Project Study Report (PSR) by the Mountain House development and are to be implemented when warranted (See College Park at Mountain House Specific Plan III Draft EIR for details).

Except where previously noted, it is assumed in this analysis that the transportation network under cumulative conditions would be the same as the project transportation network.

Cumulative Intersection Levels of Service

The cumulative traffic volumes at the study intersections were obtained from the College Park at Mountain House Specific Plan III EIR, which includes the full build out of the Mountain House development. Traffic from the Sand Hill Wind Project and 10 Grant Line Road Service Station project were added to these volumes to derive baseline cumulative volumes. The baseline cumulative volumes are shown on Figure 5. Traffic from the proposed compost facility was added to the cumulative baseline volumes to analyze the impacts of the proposed project under cumulative conditions. The results of the signalized intersection level of service analysis under cumulative conditions are summarized in Table 10. The results indicate that all of the study intersections would operate at an acceptable level of service (LOS E or better) with and without the project. Therefore, the project would have a less than significant impact at the two study intersections under cumulative conditions. The levels of service calculation sheets are included in Appendix B.

Table 10
Cumulative Intersection Levels of Service

Intersection	Peak Hour	Cumulative Conditions				
		Without Project		With Project		
		Avg. Delay	LOS	Avg. Delay	LOS	Incr. In Delay
Grant Line Road and I-580 EB	AM	18.6	B	18.7	B	0.1
	PM	39.0	D	40.0	D	1.0
Grant Line Road and I-580 WB	AM	27.1	C	27.2	C	0.1
	PM	19.5	B	20.3	C	0.8

Note: Intersections were run as signalized under cumulative conditions.

Jess Ranch

<p>1</p> <p>95(14) ↓ ↔ 112(518)</p> <p>I-580 EB Off-Ramp</p>	<p>2</p> <p>1627(335) ↔ 130(512) ↓</p> <p>526(68) ↔ 416(2) ↔ 77(13)</p> <p>I-580 WB Off-Ramp</p>
<p>287(1631) ↔ 8(23) ↔ 10(60) ↓</p> <p>Grant Line Rd</p>	<p>41(17) ↔ 37(66) ↔</p> <p>Grant Line Rd</p> <p>44(11) ↔ 284(1637) ↔</p> <p>Grant Line Rd</p>

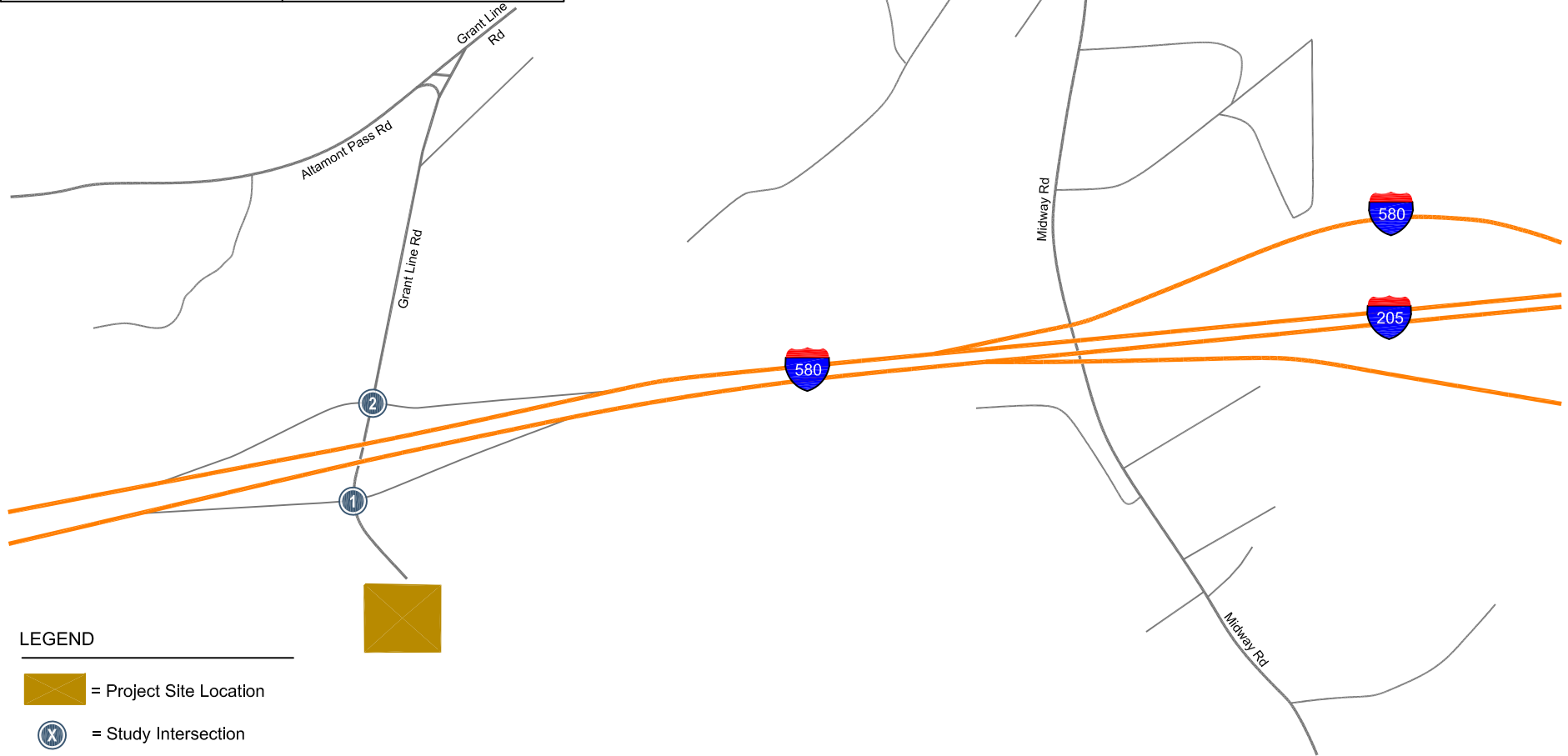

LEGEND

 = Project Site Location

 = Study Intersection

XX(X) = AM(PM) Peak-Hour Traffic Volumes

Figure 5
Cumulative No Project Traffic Volumes

Cumulative Freeway Segment Level of Service Analysis

Cumulative AM and PM peak hour volumes for the study freeway segments were obtained from the 2040 Alameda County Travel Demand Model. AM and PM peak hour volumes representing the full build-out of the Mountain House development were then added to the Alameda County Travel Demand volumes. The results of the freeway level of service analysis are summarized in Table 11. The results show that under cumulative conditions without project traffic, traffic demand in the peak commute directions (westbound in the AM and eastbound in the PM) are projected to greatly exceed the freeway capacity. This increase is predominately due to traffic from the Mountain House development and regional development growth in San Joaquin and Alameda Counties. In reality, this amount of traffic could not be accommodated on I-580. Therefore, it is likely that speeds will decrease in the future as the freeway approaches capacity in the peak commute direction. In addition, the freeway will experience congestion over a longer time period until the demand in excess of capacity is served.

As shown on Table 11, the project would add traffic to four roadway segments that are projected to operate at LOS F during the AM or PM peak hours. The LOS standard for study freeway segments is LOS E. According to the previously described impact criteria, if a study segment is already operating below its level of service standard, then an impact by the project would be created if the project increases traffic substantially relative to the existing capacity of the facility. Most jurisdictions consider a project contribution to be significant when its traffic constitutes between 1% and 3% of the capacity of a freeway segment. For the study segments on I-580, 1% of capacity (an increase in V/C ratio of .01) would equate to 80 peak hour project trips. At the study segments that are projected to operate at LOS F, project traffic would constitute less than 1% of capacity. Therefore, the project’s impact to these freeway segments is considered less than significant.

Table 11
Cumulative Freeway Levels of Service (based on V/C Ratio)

Freeway	Segment	Direction	Peak Hour	No Project		Project			Impact?
				Volume	LOS	Project Trips	LOS	V/C Increase	
I-580	North Flynn Road to Grant Line Road	EB	AM	5,050	C	7	C	0.001	NO
		EB	PM	14,199	F	3	F	0.000	NO
I-580	Grant Line Road to I-205	EB	AM	4,880	C	1	C	0.000	NO
		EB	PM	12,908	F	6	F	0.001	NO
I-580	I-205 to Grant Line Road	WB	AM	13,372	F	5	F	0.000	NO
		WB	PM	6,103	C	1	C	0.000	NO
I-580	Grant Line Road to North Flynn Road	WB	AM	14,469	F	2	F	0.000	NO
		WB	PM	6,402	D	7	D	0.001	NO

5. Other Transportation Issues

This chapter presents an analysis of other transportation issues associated with the development including:

- Bike, pedestrian and transit facilities
- Site circulation, access review, and parking supply
- Construction impacts

Unlike the level of service impact methodology, the analyses in this chapter are based on professional judgment in accordance with the standards and methods employed by the traffic engineering community.

Other Transportation Modes

There are currently no bike routes, bike lanes, paths or sidewalks in the project area. Given the remote location of the project site, there are unlikely to be any bike or pedestrian trips to and from the project. Therefore, the impact on bike and pedestrian facilities was considered to be less than significant.

There is currently no transit service to the project site. Given the remote location of the project site and the low number of employees, it would be uneconomical to route transit service to and from the project. Therefore, the impact on transit facilities was considered to be less than significant.

Site Access, On-Site Circulation, Parking

Site access and on-site circulation were evaluated using commonly accepted transportation planning principles. This review is based on the preliminary site plan provided by the project applicant and shown on Figure 6.

Access to the site would be provided by one driveway located on the existing cul-de-sac at the southern terminus of Grant Line Road. The existing driveway is approximately 14 feet wide and accommodates 2-way traffic. It is currently unpaved. Access to this driveway would operate with little or no delay because there is almost no conflicting traffic at the end of the cul-de-sac. It is anticipated that stopped delays at the driveway would be less than 10 seconds per vehicle. Because delays would be so low, passenger vehicle and truck queues at the driveway would rarely exceed one vehicle.

The site plan shows a 20 feet wide access road that would provide connection between Jess Ranch Road and the composting facility. The site plan shows three pads, each 4.6 acres with 34 windrows. In addition, a 3 acre parcel of land adjacent to pad 1, would be used for curing/storage and a processing building. The site plan also shows a parking lot, an administrative building and truck scales at the entrance to the composting facility. The

access road would provide access to the three windrows pads, curing/storage parcel and the processing building. The site plan is only conceptual. It does not show any designated areas for loading/unloading, nor does it include detailed dimensions. Based on our review of the conceptual site plan, the following is recommended:

- Prior to final design, County staff should review the design of the private access roadway to insure it would provide adequate width to accommodate simultaneous passing trucks in opposite directions. The pavement section should be sufficient to accommodate the large number of heavy vehicles to and from the site. Failure to provide a sufficient pavement section could lead to poor traction on the private roadway, thereby decreasing roadway safety.
- Landscaping and equipment are not shown on the current plan. It is recommended that, near all loading areas and intersections, sight distance triangles be maintained so that trucks and passenger vehicles have an unobstructed view of oncoming traffic. In addition, the project site plan should be reviewed by County staff to insure all truck movements are permissible on site.
- Parking is not shown on the current plan. The applicant should provide a sufficient number of parking spaces to accommodate employees onsite. In the publication *Parking Generation, 3rd Edition*, by ITE, the 85th percentile parking demand for light industrial uses is 0.81 spaces per employee. However, the project area contains no transit service and the distance from residential uses makes access via biking or walking impractical. Based on the number of employees and visitors anticipated, we recommend that one parking space be provided for each employee, plus five additional spaces for visitors or deliveries.

Construction Impacts

During construction, there would be a significant number of workers and trucks destined to and from the project site. However, the number of trips on the roadway during construction would be less than the number of trips that the site produces once it is constructed and occupied.

As part of this proposed facility, the project would construct a water pipeline along Grant Line Road. Although the ultimate alignment within Grant Line Road is not known at this time, there would likely be construction within the public right of way. For this reason, it is recommended that the applicant prepare a traffic handling plan that provides the warning and regulatory traffic control devices needed during construction.

Vehicle Miles Traveled

Given that Alameda County has not adopted thresholds of significance related to per capita Vehicle Miles Traveled (VMT), the VMT presented in this report is for informational purposes only. It is not intended to provide any indication of the significance of transportation impacts of the project.

Truck VMT

Based on information provided by the applicant, approximately 40 trucks would be hauling waste materials (greenwaste, foodwaste and biosolids) that are currently going to other existing facilities, 40 trucks would be transporting composting products to agricultural sites located within 30 to 35 miles and 5 trucks would be delivering water to the site.

Local municipal greenwaste and foodwaste is currently being trucked to central waste processing facilities where organics are separated. Once the organics are processed, the material is then trucked to existing composting facilities located in Santa Clara County, Marin County and Stanislaus County. Material being transported to the composting facility in Stanislaus County facility passes by the project site on their route.

In the case of biosolids, wastewater treatment plants typically contract with private companies that truck the material to land application sites in Solano County, Sacramento County and Merced County. Biosolids transported to Sacramento County and Merced County pass by the project site on their way to the land application sites. Biosolids transported to Solano County must travel significantly further than the project site.

On an average, the distance from potential customers (municipal waste processing facilities and wastewater treatment plants) is approximately 35 miles one-way. Based on 85 trucks coming and leaving the project site, it is estimated that the project would generate a total of 5,950 daily truck VMT (85 trucks x 35 miles x 2). However, as previously described, this is a worstcase estimate as a significant percentage of these truck haul trips already exist on the road today and are passing by the project site.

Worker VMT

Based on information provided by the applicant, there would be 12 employees on site on a daily basis. Daily vehicle miles traveled for projects in the bay area are presented on the Metropolitan Transportation Commission (MTC) website based on the travel demand forecast model. The Year 2020 Plan Bay Area model forecasted daily VMT for workers in the vicinity of the project site is 33.8 miles per worker. With a total of 12 employees on site, it is estimated that the project would generate a total of 406 worker VMT.

Total VMT

For a total of 12 employees and a total of 85 trucks entering and leaving the site, the project would generate a total of 6,356 daily VMT (5,950 truck VMT + 406 worker VMT).

F:\2025-01-30_1710\shares\Public\JESS RANCH\SITE-REV1.dwg 9/2/2025 7:08:06 AM PST

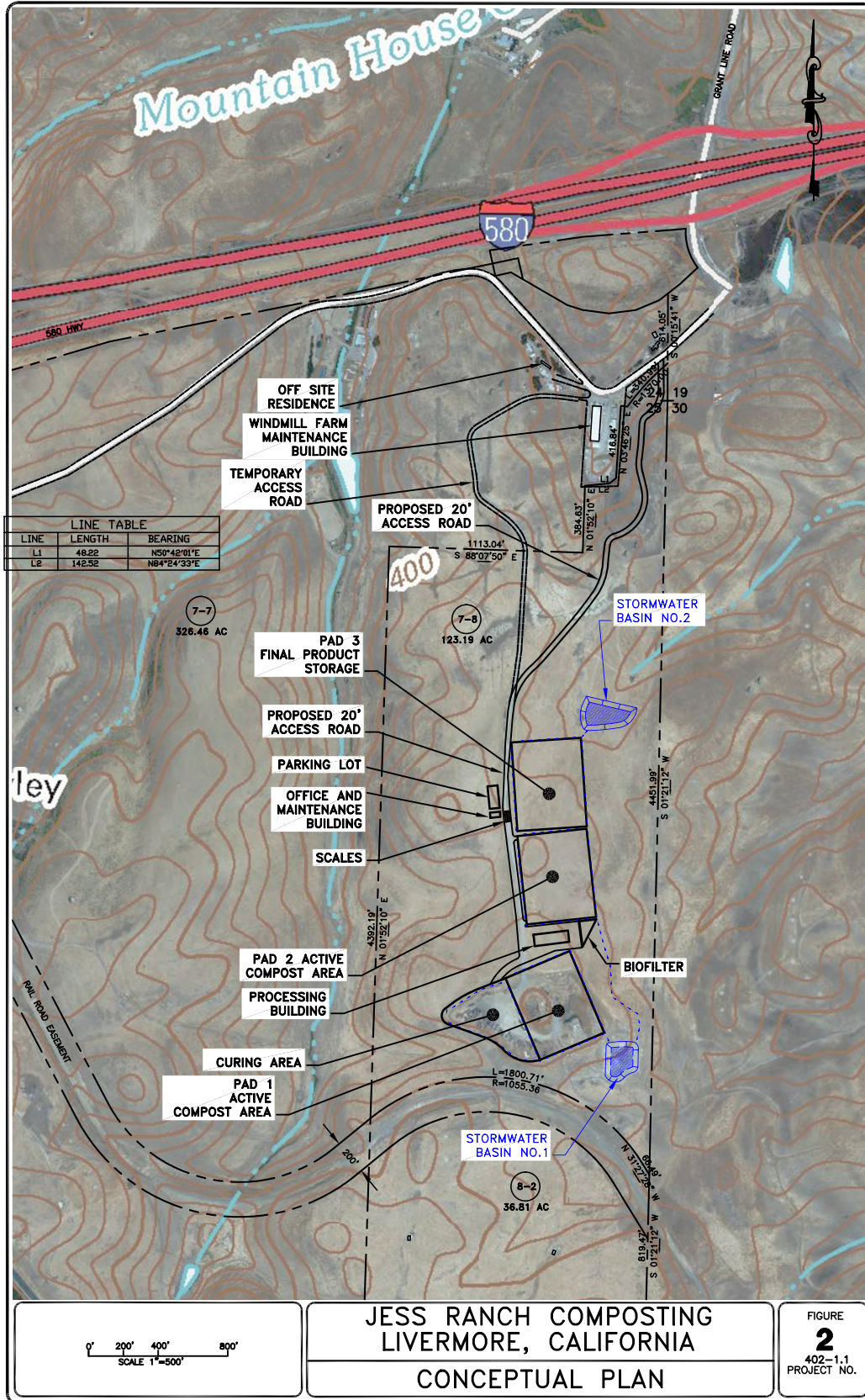

Figure 6
Project Site Plan

**Jess Ranch Composting Facility
Technical Appendices**

Appendix A
Traffic Counts

Jess Ranch Rd I-580 EB Ramps



Peak Hour

Date: 10-09-2018
Count Period: 7:00 AM to 9:00 AM
Peak Hour: 8:00 AM to 9:00 AM

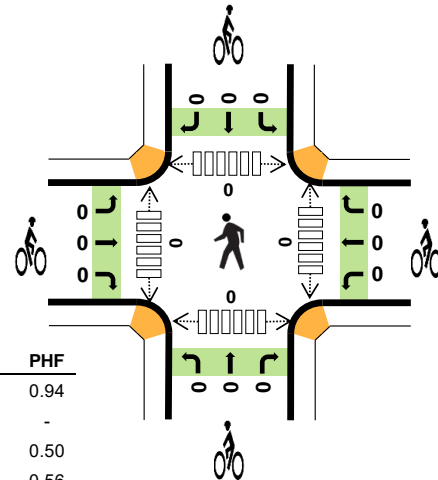
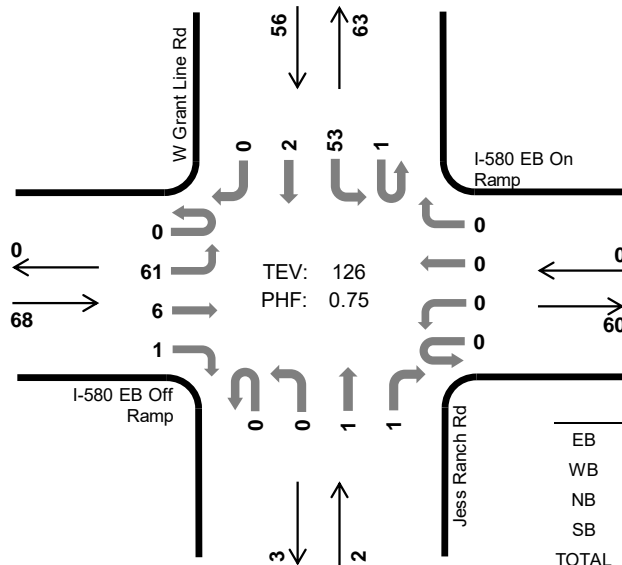

	HV %:	PHF
EB	19.1%	0.94
WB	-	-
NB	0.0%	0.50
SB	7.1%	0.56
TOTAL	13.5%	0.75

Two-Hour Count Summaries

Interval Start	I-580 EB Off Ramp				I-580 EB On Ramp				Jess Ranch Rd				W Grant Line Rd				15-min Total	Rolling One Hour
	Eastbound				Westbound				Northbound				Southbound					
	UT	LT	TH	RT	UT	LT	TH	RT	UT	LT	TH	RT	UT	LT	TH	RT		
7:00 AM	0	14	0	0	0	0	0	0	0	0	3	0	0	15	1	0	33	0
7:15 AM	0	23	3	0	0	0	0	0	0	0	0	0	0	4	0	0	30	0
7:30 AM	0	19	3	0	0	0	0	0	0	0	0	0	0	9	0	0	31	0
7:45 AM	0	15	1	0	0	0	0	0	0	0	0	0	0	9	0	0	25	119
8:00 AM	0	16	1	0	0	0	0	0	0	0	0	0	0	13	0	0	30	116
8:15 AM	0	15	3	0	0	0	0	0	0	0	0	1	0	7	1	0	27	113
8:30 AM	0	15	1	0	0	0	0	0	0	0	1	0	0	10	0	0	27	109
8:45 AM	0	15	1	1	0	0	0	0	0	0	0	0	1	23	1	0	42	126
Count Total	0	132	13	1	0	0	0	0	0	0	4	1	1	90	3	0	245	0
Peak Hour	All	0	61	6	1	0	0	0	0	0	1	1	1	53	2	0	126	0
	HV	0	8	5	0	0	0	0	0	0	0	0	0	4	0	0	17	0
	HV%	-	13%	83%	0%	-	-	-	-	-	-	0%	0%	0%	8%	0%	-	13%

Note: Two-hour count summary volumes include heavy vehicles but exclude bicycles in overall count.

Interval Start	Heavy Vehicle Totals					Bicycles					Pedestrians (Crossing Leg)				
	EB	WB	NB	SB	Total	EB	WB	NB	SB	Total	East	West	North	South	Total
7:00 AM	1	0	0	4	5	0	0	0	0	0	0	0	0	0	0
7:15 AM	4	0	0	2	6	0	0	0	0	0	0	0	0	0	0
7:30 AM	3	0	0	2	5	0	0	0	0	0	0	0	0	0	0
7:45 AM	1	0	0	1	2	0	0	0	0	0	0	0	0	0	0
8:00 AM	2	0	0	0	2	0	0	0	0	0	0	0	0	0	0
8:15 AM	4	0	0	0	4	0	0	0	0	0	0	0	0	0	0
8:30 AM	2	0	0	2	4	0	0	0	0	0	0	0	0	0	0
8:45 AM	5	0	0	2	7	0	0	0	0	0	0	0	0	0	0
Count Total	22	0	0	13	35	0	0	0	0	0	0	0	0	0	0
Peak Hour	13	0	0	4	17	0	0	0	0	0	0	0	0	0	0

Two-Hour Count Summaries - Heavy Vehicles																		
Interval Start	I-580 EB Off Ramp				I-580 EB On Ramp				Jess Ranch Rd				W Grant Line Rd				15-min Total	Rolling One Hour
	Eastbound				Westbound				Northbound				Southbound					
	UT	LT	TH	RT	UT	LT	TH	RT	UT	LT	TH	RT	UT	LT	TH	RT		
7:00 AM	0	1	0	0	0	0	0	0	0	0	0	0	0	4	0	0	5	0
7:15 AM	0	1	3	0	0	0	0	0	0	0	0	0	0	2	0	0	6	0
7:30 AM	0	0	3	0	0	0	0	0	0	0	0	0	0	2	0	0	5	0
7:45 AM	0	0	1	0	0	0	0	0	0	0	0	0	0	1	0	0	2	18
8:00 AM	0	2	0	0	0	0	0	0	0	0	0	0	0	0	0	0	2	15
8:15 AM	0	1	3	0	0	0	0	0	0	0	0	0	0	0	0	0	4	13
8:30 AM	0	1	1	0	0	0	0	0	0	0	0	0	0	2	0	0	4	12
8:45 AM	0	4	1	0	0	0	0	0	0	0	0	0	0	2	0	0	7	17
Count Total	0	10	12	0	0	0	0	0	0	0	0	0	0	13	0	0	35	0
Peak Hour	0	8	5	0	0	0	0	0	0	0	0	0	0	4	0	0	17	0
Two-Hour Count Summaries - Bikes																		
Interval Start	I-580 EB Off Ramp			I-580 EB On Ramp			Jess Ranch Rd			W Grant Line Rd			15-min Total	Rolling One Hour				
	Eastbound			Westbound			Northbound			Southbound								
	LT	TH	RT	LT	TH	RT	LT	TH	RT	LT	TH	RT						
7:00 AM	0	0	0	0	0	0	0	0	0	0	0	0	0	0	0	0	0	0
7:15 AM	0	0	0	0	0	0	0	0	0	0	0	0	0	0	0	0	0	0
7:30 AM	0	0	0	0	0	0	0	0	0	0	0	0	0	0	0	0	0	0
7:45 AM	0	0	0	0	0	0	0	0	0	0	0	0	0	0	0	0	0	0
8:00 AM	0	0	0	0	0	0	0	0	0	0	0	0	0	0	0	0	0	0
8:15 AM	0	0	0	0	0	0	0	0	0	0	0	0	0	0	0	0	0	0
8:30 AM	0	0	0	0	0	0	0	0	0	0	0	0	0	0	0	0	0	0
8:45 AM	0	0	0	0	0	0	0	0	0	0	0	0	0	0	0	0	0	0
Count Total	0	0	0	0	0	0	0	0	0	0	0	0	0	0	0	0	0	0
Peak Hour	0	0	0	0	0	0	0	0	0	0	0	0	0	0	0	0	0	0
<i>Note: U-Turn volumes for bikes are included in Left-Turn, if any.</i>																		

Two-Hour Count Summaries - Heavy Vehicles																		
Interval Start	I-580 EB Off Ramp				I-580 EB On Ramp				Jess Ranch Rd				W Grant Line Rd				15-min Total	Rolling One Hour
	Eastbound				Westbound				Northbound				Southbound					
	UT	LT	TH	RT	UT	LT	TH	RT	UT	LT	TH	RT	UT	LT	TH	RT		
4:00 PM	0	1	3	0	0	0	0	0	0	0	0	0	0	3	0	0	7	0
4:15 PM	0	0	1	0	0	0	0	0	0	0	0	0	0	2	0	0	3	0
4:30 PM	0	0	1	0	0	0	0	0	0	0	0	0	0	6	0	0	7	0
4:45 PM	0	1	3	0	0	0	0	0	0	0	0	0	0	4	0	0	8	25
5:00 PM	0	0	0	0	0	0	0	0	0	0	0	0	0	4	0	0	4	22
5:15 PM	0	0	4	0	0	0	0	0	0	0	0	0	0	6	0	0	10	29
5:30 PM	0	0	1	0	0	0	0	0	0	0	0	0	0	2	0	0	3	25
5:45 PM	0	0	0	0	0	0	0	0	0	0	0	0	0	1	0	0	1	18
Count Total	0	2	13	0	0	0	0	0	0	0	0	0	0	28	0	0	43	0
Peak Hour	0	1	8	0	0	0	0	0	0	0	0	0	0	20	0	0	29	0
Two-Hour Count Summaries - Bikes																		
Interval Start	I-580 EB Off Ramp			I-580 EB On Ramp			Jess Ranch Rd			W Grant Line Rd			15-min Total	Rolling One Hour				
	Eastbound			Westbound			Northbound			Southbound								
	LT	TH	RT	LT	TH	RT	LT	TH	RT	LT	TH	RT						
4:00 PM	0	0	0	0	0	0	0	0	0	0	0	0	0	0	0	0	0	0
4:15 PM	0	0	0	0	0	0	0	0	0	0	0	0	0	0	0	0	0	0
4:30 PM	0	0	0	0	0	0	0	0	0	0	0	0	0	0	0	0	0	0
4:45 PM	0	0	0	0	0	0	0	0	0	0	0	0	0	0	0	0	0	0
5:00 PM	0	0	0	0	0	0	0	0	0	0	0	0	0	0	0	0	0	0
5:15 PM	0	0	0	0	0	0	0	0	0	0	0	0	0	0	0	0	0	0
5:30 PM	0	0	0	0	0	0	0	0	0	0	0	0	0	0	0	0	0	0
5:45 PM	0	0	0	0	0	0	0	0	0	0	0	0	0	0	0	0	0	0
Count Total	0	0	0	0	0	0	0	0	0	0	0	0	0	0	0	0	0	0
Peak Hour	0	0	0	0	0	0	0	0	0	0	0	0	0	0	0	0	0	0
<i>Note: U-Turn volumes for bikes are included in Left-Turn, if any.</i>																		

W Grantline Rd I-580 WB Ramps



Date: 10-09-2018
Count Period: 7:00 AM to 9:00 AM
Peak Hour: 7:00 AM to 8:00 AM

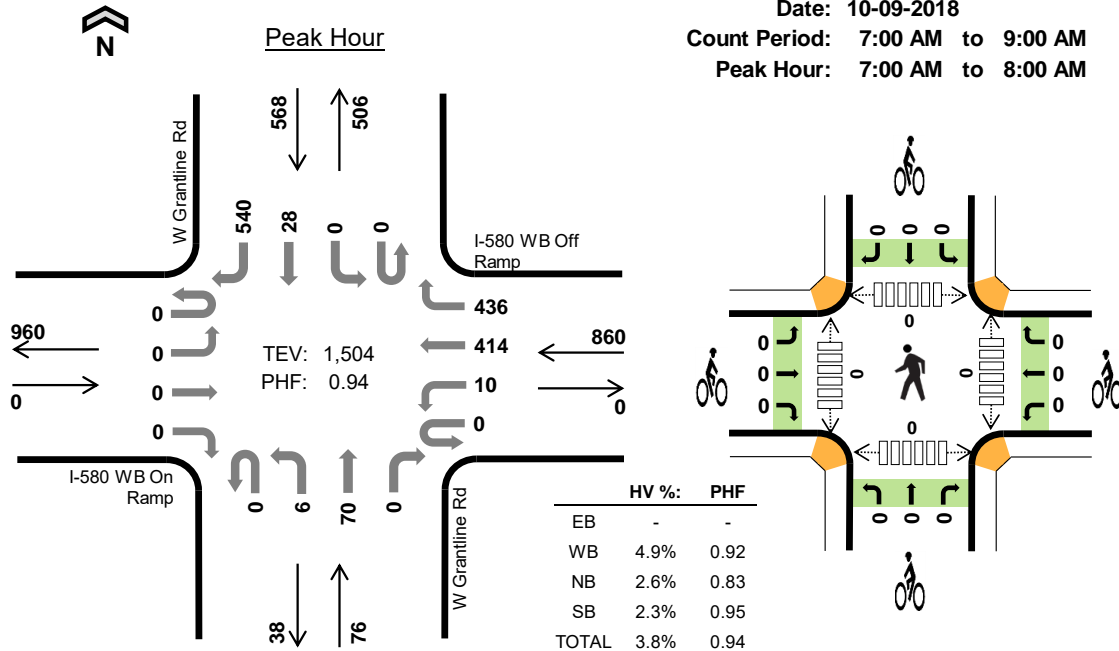

Two-Hour Count Summaries

Interval Start	I-580 WB On Ramp				I-580 WB Off Ramp				W Grantline Rd Northbound				W Grantline Rd Southbound				15-min Total	Rolling One Hour	
	UT	LT	TH	RT	UT	LT	TH	RT	UT	LT	TH	RT	UT	LT	TH	RT			
7:00 AM	0	0	0	0	0	4	104	113	0	4	13	0	0	0	13	130	381	0	
7:15 AM	0	0	0	0	0	1	110	122	0	2	21	0	0	0	3	140	399	0	
7:30 AM	0	0	0	0	0	2	108	103	0	0	20	0	0	0	6	127	366	0	
7:45 AM	0	0	0	0	0	3	92	98	0	0	16	0	0	0	6	143	358	1,504	
8:00 AM	0	0	0	0	0	4	89	100	0	0	14	0	0	0	9	144	360	1,483	
8:15 AM	0	0	0	0	0	4	91	112	0	1	15	0	0	0	4	150	377	1,461	
8:30 AM	0	0	0	0	0	2	77	75	0	1	15	0	0	0	8	158	336	1,431	
8:45 AM	0	0	0	0	0	10	54	104	0	1	15	0	0	0	16	127	327	1,400	
Count Total	0	0	0	0	0	30	725	827	0	9	129	0	0	0	65	1,119	2,904	0	
Peak Hour	All	0	0	0	0	0	10	414	436	0	6	70	0	0	0	28	540	1,504	0
	HV	0	0	0	0	0	2	34	6	0	1	1	0	0	0	7	6	57	0
	HV%	-	-	-	-	-	20%	8%	1%	-	17%	1%	-	-	-	25%	1%	4%	0

Note: Two-hour count summary volumes include heavy vehicles but exclude bicycles in overall count.

Interval Start	Heavy Vehicle Totals					Bicycles					Pedestrians (Crossing Leg)				
	EB	WB	NB	SB	Total	EB	WB	NB	SB	Total	East	West	North	South	Total
7:00 AM	0	13	0	4	17	0	0	0	0	0	0	0	0	0	0
7:15 AM	0	10	2	2	14	0	0	0	0	0	0	0	0	0	0
7:30 AM	0	9	0	5	14	0	0	0	0	0	0	0	0	0	0
7:45 AM	0	10	0	2	12	0	0	0	0	0	0	0	0	0	0
8:00 AM	0	14	2	0	16	0	0	0	0	0	0	0	0	0	0
8:15 AM	0	17	1	2	20	0	0	0	0	0	0	0	0	0	0
8:30 AM	0	9	1	3	13	0	0	0	0	0	0	0	0	0	0
8:45 AM	0	8	4	4	16	0	0	0	0	0	0	0	0	0	0
Count Total	0	90	10	22	122	0	0	0	0	0	0	0	0	0	0
Peak Hour	0	42	2	13	57	0	0	0	0	0	0	0	0	0	0

Two-Hour Count Summaries - Heavy Vehicles																		
Interval Start	I-580 WB On Ramp				I-580 WB Off Ramp				W Grantline Rd				W Grantline Rd				15-min Total	Rolling One Hour
	Eastbound				Westbound				Northbound				Southbound					
	UT	LT	TH	RT	UT	LT	TH	RT	UT	LT	TH	RT	UT	LT	TH	RT		
7:00 AM	0	0	0	0	0	1	11	1	0	0	0	0	0	0	3	1	17	0
7:15 AM	0	0	0	0	0	1	9	0	0	1	1	0	0	0	1	1	14	0
7:30 AM	0	0	0	0	0	0	6	3	0	0	0	0	0	0	2	3	14	0
7:45 AM	0	0	0	0	0	0	8	2	0	0	0	0	0	0	1	1	12	57
8:00 AM	0	0	0	0	0	0	9	5	0	0	2	0	0	0	0	0	16	56
8:15 AM	0	0	0	0	0	0	12	5	0	1	0	0	0	0	0	2	20	62
8:30 AM	0	0	0	0	0	0	6	3	0	0	1	0	0	0	2	1	13	61
8:45 AM	0	0	0	0	0	2	5	1	0	0	4	0	0	0	0	4	16	65
Count Total	0	0	0	0	0	4	66	20	0	2	8	0	0	0	9	13	122	0
Peak Hour	0	0	0	0	0	2	34	6	0	1	1	0	0	0	7	6	57	0

Two-Hour Count Summaries - Bikes																	
Interval Start	I-580 WB On Ramp			I-580 WB Off Ramp			W Grantline Rd			W Grantline Rd			15-min Total	Rolling One Hour			
	Eastbound			Westbound			Northbound			Southbound							
	LT	TH	RT	LT	TH	RT	LT	TH	RT	LT	TH	RT					
7:00 AM	0	0	0	0	0	0	0	0	0	0	0	0	0	0			
7:15 AM	0	0	0	0	0	0	0	0	0	0	0	0	0	0			
7:30 AM	0	0	0	0	0	0	0	0	0	0	0	0	0	0			
7:45 AM	0	0	0	0	0	0	0	0	0	0	0	0	0	0			
8:00 AM	0	0	0	0	0	0	0	0	0	0	0	0	0	0			
8:15 AM	0	0	0	0	0	0	0	0	0	0	0	0	0	0			
8:30 AM	0	0	0	0	0	0	0	0	0	0	0	0	0	0			
8:45 AM	0	0	0	0	0	0	0	0	0	0	0	0	0	0			
Count Total	0	0	0	0	0	0	0	0	0	0	0	0	0	0			
Peak Hour	0	0	0	0	0	0	0	0	0	0	0	0	0	0			

Note: U-Turn volumes for bikes are included in Left-Turn, if any.

W Grantline Rd I-580 WB Ramps



Peak Hour

Date: 10-09-2018
Count Period: 4:00 PM to 6:00 PM
Peak Hour: 4:15 PM to 5:15 PM

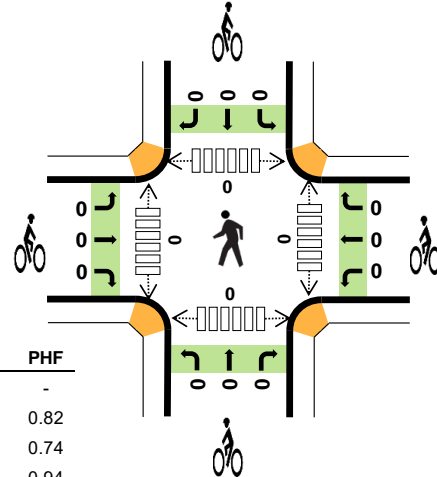
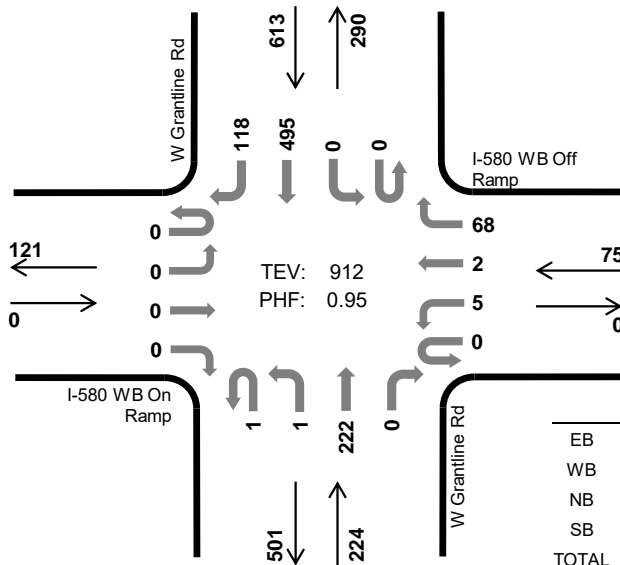

	HV %:	PHF
EB	-	-
WB	5.3%	0.82
NB	0.4%	0.74
SB	2.6%	0.94
TOTAL	2.3%	0.95

Two-Hour Count Summaries

Interval Start	I-580 WB On Ramp				I-580 WB Off Ramp				W Grantline Rd Northbound				W Grantline Rd Southbound				15-min Total	Rolling One Hour	
	UT	LT	TH	RT	UT	LT	TH	RT	UT	LT	TH	RT	UT	LT	TH	RT			
4:00 PM	0	0	0	0	0	0	1	8	0	3	37	0	0	0	119	27	195	0	
4:15 PM	0	0	0	0	0	0	0	23	0	0	40	0	0	0	138	25	226	0	
4:30 PM	0	0	0	0	0	4	0	12	0	0	46	0	0	0	114	33	209	0	
4:45 PM	0	0	0	0	0	0	0	17	0	1	61	0	0	0	130	27	236	866	
5:00 PM	0	0	0	0	0	1	2	16	1	0	75	0	0	0	113	33	241	912	
5:15 PM	0	0	0	0	0	2	2	10	0	0	63	0	0	0	118	26	221	907	
5:30 PM	0	0	0	0	0	1	0	13	0	0	48	0	0	0	110	27	199	897	
5:45 PM	0	0	0	0	0	1	0	14	0	1	71	0	0	0	124	26	237	898	
Count Total	0	0	0	0	0	9	5	113	1	5	441	0	0	0	966	224	1,764	0	
Peak Hour	All	0	0	0	0	0	5	2	68	1	1	222	0	0	0	495	118	912	0
	HV	0	0	0	0	0	0	0	4	0	1	0	0	0	0	16	0	21	0
	HV%	-	-	-	-	-	0%	0%	6%	0%	100%	0%	-	-	-	3%	0%	2%	0

Note: Two-hour count summary volumes include heavy vehicles but exclude bicycles in overall count.

Interval Start	Heavy Vehicle Totals					Bicycles					Pedestrians (Crossing Leg)				
	EB	WB	NB	SB	Total	EB	WB	NB	SB	Total	East	West	North	South	Total
4:00 PM	0	0	1	3	4	0	0	0	0	0	0	0	0	0	0
4:15 PM	0	1	0	2	3	0	0	0	0	0	0	0	0	0	0
4:30 PM	0	0	0	6	6	0	0	0	0	0	0	0	0	0	0
4:45 PM	0	3	1	4	8	0	0	0	0	0	0	0	0	0	0
5:00 PM	0	0	0	4	4	0	0	0	0	0	0	0	0	0	0
5:15 PM	0	1	0	5	6	0	0	0	0	0	0	0	0	0	0
5:30 PM	0	0	0	2	2	0	0	0	0	0	0	0	0	0	0
5:45 PM	0	1	0	1	2	0	0	0	0	0	0	0	0	0	0
Count Total	0	6	2	27	35	0	0	0	0	0	0	0	0	0	0
Peak Hour	0	4	1	16	21	0	0	0	0	0	0	0	0	0	0

Two-Hour Count Summaries - Heavy Vehicles																		
Interval Start	I-580 WB On Ramp				I-580 WB Off Ramp				W Grantline Rd				W Grantline Rd				15-min Total	Rolling One Hour
	Eastbound				Westbound				Northbound				Southbound					
	UT	LT	TH	RT	UT	LT	TH	RT	UT	LT	TH	RT	UT	LT	TH	RT		
4:00 PM	0	0	0	0	0	0	0	0	0	0	1	0	0	0	3	0	4	0
4:15 PM	0	0	0	0	0	0	0	1	0	0	0	0	0	0	2	0	3	0
4:30 PM	0	0	0	0	0	0	0	0	0	0	0	0	0	0	6	0	6	0
4:45 PM	0	0	0	0	0	0	0	3	0	1	0	0	0	0	4	0	8	21
5:00 PM	0	0	0	0	0	0	0	0	0	0	0	0	0	0	4	0	4	21
5:15 PM	0	0	0	0	0	1	0	0	0	0	0	0	0	0	5	0	6	24
5:30 PM	0	0	0	0	0	0	0	0	0	0	0	0	0	0	2	0	2	20
5:45 PM	0	0	0	0	0	0	0	1	0	0	0	0	0	0	1	0	2	14
Count Total	0	0	0	0	0	1	0	5	0	1	1	0	0	0	27	0	35	0
Peak Hour	0	0	0	0	0	0	0	4	0	1	0	0	0	0	16	0	21	0
Two-Hour Count Summaries - Bikes																		
Interval Start	I-580 WB On Ramp			I-580 WB Off Ramp			W Grantline Rd			W Grantline Rd			15-min Total	Rolling One Hour				
	Eastbound			Westbound			Northbound			Southbound								
	LT	TH	RT	LT	TH	RT	LT	TH	RT	LT	TH	RT						
4:00 PM	0	0	0	0	0	0	0	0	0	0	0	0	0	0	0	0	0	
4:15 PM	0	0	0	0	0	0	0	0	0	0	0	0	0	0	0	0	0	
4:30 PM	0	0	0	0	0	0	0	0	0	0	0	0	0	0	0	0	0	
4:45 PM	0	0	0	0	0	0	0	0	0	0	0	0	0	0	0	0	0	
5:00 PM	0	0	0	0	0	0	0	0	0	0	0	0	0	0	0	0	0	
5:15 PM	0	0	0	0	0	0	0	0	0	0	0	0	0	0	0	0	0	
5:30 PM	0	0	0	0	0	0	0	0	0	0	0	0	0	0	0	0	0	
5:45 PM	0	0	0	0	0	0	0	0	0	0	0	0	0	0	0	0	0	
Count Total	0	0	0	0	0	0	0	0	0	0	0	0	0	0	0	0	0	
Peak Hour	0	0	0	0	0	0	0	0	0	0	0	0	0	0	0	0	0	
<i>Note: U-Turn volumes for bikes are included in Left-Turn, if any.</i>																		

IDAX Data Solutions

Project: 18304 - Tracy - Jess Ranch Rd

Date: 10/9/2018

Location:		I-580 Eastbound			
Time:	Lights	Heavies	Time:	Lights	Heavies
7:00	643	113	4:00	1505	115
7:15	620	128	4:15	1410	125
7:30	579	110	4:30	1432	115
7:45	580	81	4:45	1541	102
8:00	510	106	5:00	1508	85
8:15	508	104	5:15	1400	135
8:30	538	147	5:30	1437	101
8:45	519	135	5:45	1420	88
AM Total:	4497	924	PM Total:	11653	866

Location:		I-580 Westbound			
Time:	Lights	Heavies	Time:	Lights	Heavies
7:00	1193	155	4:00	847	80
7:15	1205	144	4:15	815	86
7:30	1181	138	4:30	834	88
7:45	1201	136	4:45	812	69
8:00	1060	145	5:00	635	52
8:15	1108	180	5:15	864	83
8:30	1112	132	5:30	695	67
8:45	1175	188	5:45	655	69
AM Total:	9235	1218	PM Total:	6157	594

Appendix B

Level of Service Calculations

Jess Ranch

Level Of Service Computation Report
 2000 HCM Unsignalized (Future Volume Alternative)
 Existing AM

Intersection #1: Grant Line Rd and I-580 EB

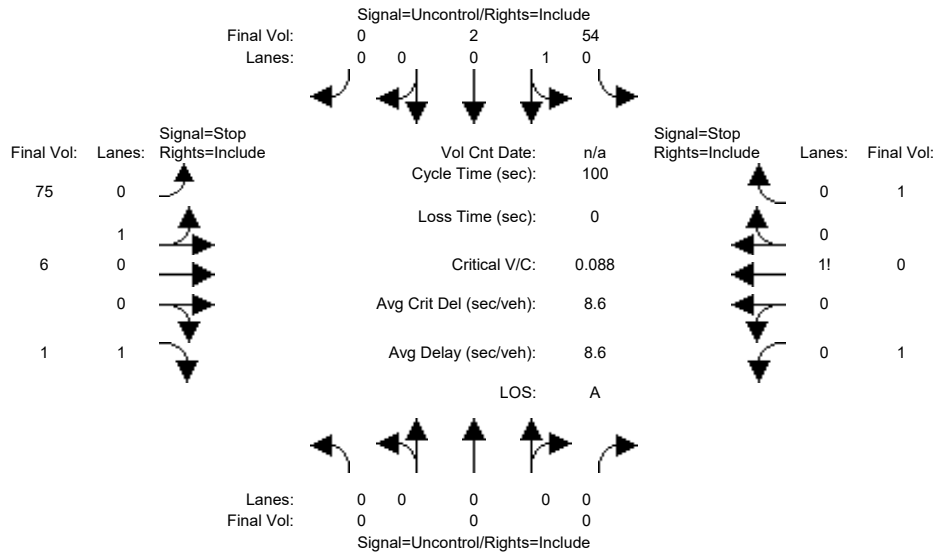

Street Name: Grant Line Road I-580 EB Offramp
 Approach: North Bound South Bound East Bound West Bound
 Movement: L - T - R L - T - R L - T - R L - T - R

Volume Module:

Base Vol:	0	0	0	54	2	0	75	6	1	1	0	1
Growth Adj:	1.00	1.00	1.00	1.00	1.00	1.00	1.00	1.00	1.00	1.00	1.00	1.00
Initial Bse:	0	0	0	54	2	0	75	6	1	1	0	1
Added Vol:	0	0	0	0	0	0	0	0	0	0	0	0
PasserByVol:	0	0	0	0	0	0	0	0	0	0	0	0
Initial Fut:	0	0	0	54	2	0	75	6	1	1	0	1
User Adj:	1.00	1.00	1.00	1.00	1.00	1.00	1.00	1.00	1.00	1.00	1.00	1.00
PHF Adj:	1.00	1.00	1.00	1.00	1.00	1.00	1.00	1.00	1.00	1.00	1.00	1.00
PHF Volume:	0	0	0	54	2	0	75	6	1	1	0	1
Reduct Vol:	0	0	0	0	0	0	0	0	0	0	0	0
FinalVolume:	0	0	0	54	2	0	75	6	1	1	0	1

Critical Gap Module:

Critical Gp:	xxxxx	xxxx	xxxxxx	4.1	xxxx	xxxxxx	7.1	6.5	6.2	7.1	6.5	6.2
FollowUpTim:	xxxxx	xxxx	xxxxxx	2.2	xxxx	xxxxxx	3.5	4.0	3.3	3.5	4.0	3.3

Capacity Module:

Cnflct Vol:	xxxx	xxxx	xxxxxx	0	xxxx	xxxxxx	110	110	2	114	110	0
Potent Cap.:	xxxx	xxxx	xxxxxx	1636	xxxx	xxxxxx	873	784	1088	868	784	1091
Move Cap.:	xxxx	xxxx	xxxxxx	1636	xxxx	xxxxxx	850	757	1088	840	757	1091
Volume/Cap:	xxxx	xxxx	xxxx	0.03	xxxx	xxxx	0.09	0.01	0.00	0.00	0.00	0.00

Level Of Service Module:

2Way95thQ:	xxxx	xxxx	xxxxxx	0.1	xxxx	xxxxxx	xxxx	xxxx	0.0	xxxx	xxxx	xxxxxx
Control Del:	xxxxx	xxxx	xxxxxx	7.3	xxxx	xxxxxx	xxxxxx	xxxx	8.3	xxxxxx	xxxx	xxxxxx
LOS by Move:	*	*	*	A	*	*	*	*	A	*	*	*
Movement:	LT - LTR - RT	LT - LTR - RT	LT - LTR - RT	LT - LTR - RT	LT - LTR - RT	LT - LTR - RT	LT - LTR - RT	LT - LTR - RT	LT - LTR - RT	LT - LTR - RT	LT - LTR - RT	
Shared Cap.:	xxxx	xxxx	xxxxxx	xxxx	xxxx	xxxxxx	842	xxxx	xxxxxx	xxxx	949	xxxxxx
SharedQueue:	xxxxx	xxxx	xxxxxx	0.1	xxxx	xxxxxx	0.3	xxxx	xxxxxx	xxxxxx	0.0	xxxxxx
Shrd ConDel:	xxxxx	xxxx	xxxxxx	7.3	xxxx	xxxxxx	9.7	xxxx	xxxxxx	xxxxxx	8.8	xxxxxx
Shared LOS:	*	*	*	A	*	*	A	*	*	*	A	*
ApproachDel:	xxxxxxx	xxxxxxx					9.7			8.8		
ApproachLOS:	*	*					A			A		

Note: Queue reported is the number of cars per lane.

Peak Hour Delay Signal Warrant Report

 Intersection #1 Grant Line Rd and I-580 EB

 Future Volume Alternative: Peak Hour Warrant NOT Met

	North Bound	South Bound	East Bound	West Bound
Approach:	North Bound	South Bound	East Bound	West Bound
Movement:	L - T - R	L - T - R	L - T - R	L - T - R
Control:	Uncontrolled	Uncontrolled	Stop Sign	Stop Sign
Lanes:	0 0 0 0 0	0 1 0 0 0	0 1 0 0 1	0 0 1! 0 0
Initial Vol:	0 0 0	54 2 0	75 6 1	1 0 1
ApproachDel:	xxxxxxx	xxxxxxx	9.7	8.8

Approach[eastbound][lanes=2][control=Stop Sign]
Signal Warrant Rule #1: [vehicle-hours=0.2]
FAIL - Vehicle-hours less than 5 for two or more lane approach.
Signal Warrant Rule #2: [approach volume=82]
FAIL - Approach volume less than 150 for two or more lane approach.
Signal Warrant Rule #3: [approach count=3][total volume=140]
FAIL - Total volume less than 650 for intersection
with less than four approaches.

Approach[westbound][lanes=1][control=Stop Sign]
Signal Warrant Rule #1: [vehicle-hours=0.0]
FAIL - Vehicle-hours less than 4 for one lane approach.
Signal Warrant Rule #2: [approach volume=2]
FAIL - Approach volume less than 100 for one lane approach.
Signal Warrant Rule #3: [approach count=3][total volume=140]
FAIL - Total volume less than 650 for intersection
with less than four approaches.

SIGNAL WARRANT DISCLAIMER
This peak hour signal warrant analysis should be considered solely as an "indicator" of the likelihood of an unsignalized intersection warranting a traffic signal in the future. Intersections that exceed this warrant are probably more likely to meet one or more of the other volume based signal warrant (such as the 4-hour or 8-hour warrants).

The peak hour warrant analysis in this report is not intended to replace a rigorous and complete traffic signal warrant analysis by the responsible jurisdiction. Consideration of the other signal warrants, which is beyond the scope of this software, may yield different results.

Peak Hour Volume Signal Warrant Report [Urban]

Intersection #1 Grant Line Rd and I-580 EB

Future Volume Alternative: Peak Hour Warrant NOT Met

	North Bound	South Bound	East Bound	West Bound
Approach:	North Bound	South Bound	East Bound	West Bound
Movement:	L - T - R	L - T - R	L - T - R	L - T - R
Control:	Uncontrolled	Uncontrolled	Stop Sign	Stop Sign
Lanes:	0 0 0 0 0	0 1 0 0 0	0 1 0 0 1	0 0 1! 0 0
Initial Vol:	0 0 0	54 2 0	75 6 1	1 0 1
Major Street Volume:	56			
Minor Approach Volume:	82			
Minor Approach Volume Threshold:	1199			

SIGNAL WARRANT DISCLAIMER
This peak hour signal warrant analysis should be considered solely as an "indicator" of the likelihood of an unsignalized intersection warranting a traffic signal in the future. Intersections that exceed this warrant are probably more likely to meet one or more of the other volume based signal warrant (such as the 4-hour or 8-hour warrants).

The peak hour warrant analysis in this report is not intended to replace a rigorous and complete traffic signal warrant analysis by the responsible jurisdiction. Consideration of the other signal warrants, which is beyond the scope of this software, may yield different results.

Jess Ranch

Level Of Service Computation Report
2000 HCM Unsignalized (Future Volume Alternative)
Existing PM

Intersection #1: Grant Line Rd and I-580 EB

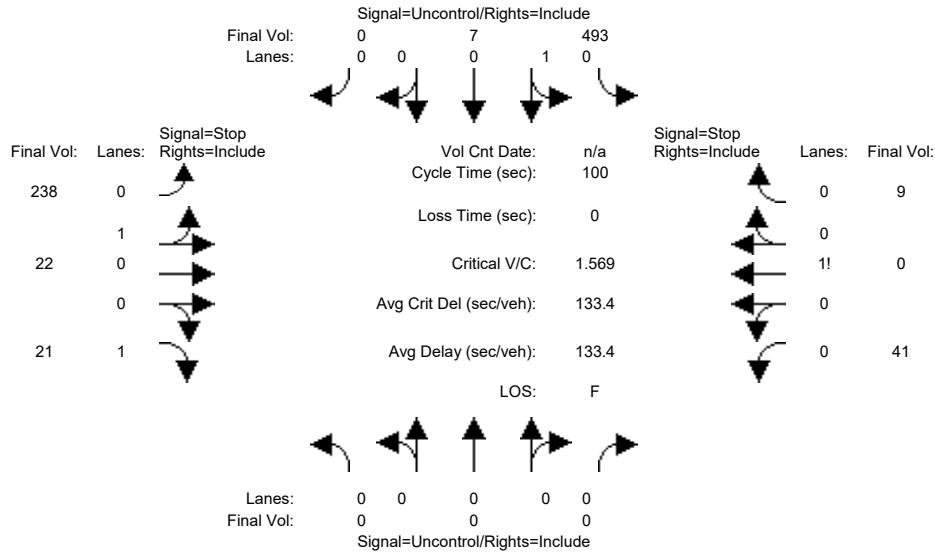

Street Name: Grant Line Road I-580 EB Offramp
 Approach: North Bound South Bound East Bound West Bound
 Movement: L - T - R L - T - R L - T - R L - T - R

Volume Module:

Base Vol:	0	0	0	493	7	0	238	22	21	41	0	9
Growth Adj:	1.00	1.00	1.00	1.00	1.00	1.00	1.00	1.00	1.00	1.00	1.00	1.00
Initial Bse:	0	0	0	493	7	0	238	22	21	41	0	9
Added Vol:	0	0	0	0	0	0	0	0	0	0	0	0
PasserByVol:	0	0	0	0	0	0	0	0	0	0	0	0
Initial Fut:	0	0	0	493	7	0	238	22	21	41	0	9
User Adj:	1.00	1.00	1.00	1.00	1.00	1.00	1.00	1.00	1.00	1.00	1.00	1.00
PHF Adj:	1.00	1.00	1.00	1.00	1.00	1.00	1.00	1.00	1.00	1.00	1.00	1.00
PHF Volume:	0	0	0	493	7	0	238	22	21	41	0	9
Reduct Vol:	0	0	0	0	0	0	0	0	0	0	0	0
FinalVolume:	0	0	0	493	7	0	238	22	21	41	0	9

Critical Gap Module:

Critical Gp:	xxxxx	xxxx	xxxxx	4.1	xxxx	xxxxxx	7.1	6.5	6.2	7.1	6.5	6.2
FollowUpTim:	xxxxx	xxxx	xxxxx	2.2	xxxx	xxxxxx	3.5	4.0	3.3	3.5	4.0	3.3

Capacity Module:

Cnflct Vol:	xxxx	xxxx	xxxxx	0	xxxx	xxxxxx	993	993	7	1015	993	0
Potent Cap.:	xxxx	xxxx	xxxxx	1636	xxxx	xxxxxx	226	247	1081	219	247	1091
Move Cap.:	xxxx	xxxx	xxxxx	1636	xxxx	xxxxxx	152	145	1081	129	145	1091
Volume/Cap:	xxxx	xxxx	xxxx	0.30	xxxx	xxxxxx	1.57	0.15	0.02	0.32	0.00	0.01

Level Of Service Module:

2Way95thQ:	xxxx	xxxx	xxxxx	1.3	xxxx	xxxxxx	xxxx	xxxx	0.1	xxxx	xxxx	xxxxx
Control Del:	xxxxx	xxxx	xxxxx	8.1	xxxxx	xxxxxx	xxxxxx	xxxx	8.4	xxxxxx	xxxx	xxxxxx
LOS by Move:	*	*	*	A	*	*	*	*	A	*	*	*
Movement:	LT - LTR - RT	LT - LTR - RT	LT - LTR - RT	LT - LTR - RT	LT - LTR - RT	LT - LTR - RT	LT - LTR - RT	LT - LTR - RT	LT - LTR - RT	LT - LTR - RT	LT - LTR - RT	LT - LTR - RT
Shared Cap.:	xxxx	xxxx	xxxxx	xxxx	xxxx	xxxxxx	151	xxxx	xxxxxx	xxxx	154	xxxxxx
SharedQueue:	xxxxx	xxxx	xxxxx	1.3	xxxx	xxxxxx	18.8	xxxx	xxxxxx	xxxxxx	1.3	xxxxxx
Shrd ConDel:	xxxxx	xxxx	xxxxx	8.1	xxxx	xxxxxx	402.6	xxxx	xxxxxx	xxxxxx	39.3	xxxxxx
Shared LOS:	*	*	*	A	*	*	F	*	*	*	E	*
ApproachDel:	xxxxxxx		xxxxxxx				373.1				39.3	
ApproachLOS:	*		*				F				E	

Note: Queue reported is the number of cars per lane.

Peak Hour Delay Signal Warrant Report

Intersection #1 Grant Line Rd and I-580 EB

Future Volume Alternative: Peak Hour Warrant Met

Approach:	North Bound	South Bound	East Bound	West Bound
Movement:	L - T - R	L - T - R	L - T - R	L - T - R
Control:	Uncontrolled	Uncontrolled	Stop Sign	Stop Sign
Lanes:	0 0 0 0 0	0 1 0 0 0	0 1 0 0 1	0 0 1! 0 0
Initial Vol:	0 0 0	493 7 0	238 22 21	41 0 9
ApproachDel:	xxxxxxx	xxxxxxx	373.1	39.3

Approach[eastbound][lanes=2][control=Stop Sign]
 Signal Warrant Rule #1: [vehicle-hours=29.1]
 SUCCEED - Vehicle-hours >= 5 for two or more lane approach.
 Signal Warrant Rule #2: [approach volume=281]
 SUCCEED - Approach volume >= 150 for two or more lane approach.
 Signal Warrant Rule #3: [approach count=3][total volume=831]
 SUCCEED - Total volume greater than or equal to 650 for intersection with less than four approaches.

Approach[westbound][lanes=1][control=Stop Sign]
 Signal Warrant Rule #1: [vehicle-hours=0.5]
 FAIL - Vehicle-hours less than 4 for one lane approach.
 Signal Warrant Rule #2: [approach volume=50]
 FAIL - Approach volume less than 100 for one lane approach.
 Signal Warrant Rule #3: [approach count=3][total volume=831]
 SUCCEED - Total volume greater than or equal to 650 for intersection with less than four approaches.

SIGNAL WARRANT DISCLAIMER
 This peak hour signal warrant analysis should be considered solely as an "indicator" of the likelihood of an unsignalized intersection warranting a traffic signal in the future. Intersections that exceed this warrant are probably more likely to meet one or more of the other volume based signal warrant (such as the 4-hour or 8-hour warrants).

The peak hour warrant analysis in this report is not intended to replace a rigorous and complete traffic signal warrant analysis by the responsible jurisdiction. Consideration of the other signal warrants, which is beyond the scope of this software, may yield different results.

Peak Hour Volume Signal Warrant Report [Urban]

 Intersection #1 Grant Line Rd and I-580 EB

Future Volume Alternative: Peak Hour Warrant NOT Met

Approach:	North Bound	South Bound	East Bound	West Bound
Movement:	L - T - R	L - T - R	L - T - R	L - T - R
Control:	Uncontrolled	Uncontrolled	Stop Sign	Stop Sign
Lanes:	0 0 0 0 0	0 1 0 0 0	0 1 0 0 1	0 0 1! 0 0
Initial Vol:	0 0 0	493 7 0	238 22 21	41 0 9
Major Street Volume:	500			
Minor Approach Volume:	281			
Minor Approach Volume Threshold:	511			

SIGNAL WARRANT DISCLAIMER
 This peak hour signal warrant analysis should be considered solely as an "indicator" of the likelihood of an unsignalized intersection warranting a traffic signal in the future. Intersections that exceed this warrant are probably more likely to meet one or more of the other volume based signal warrant (such as the 4-hour or 8-hour warrants).

The peak hour warrant analysis in this report is not intended to replace a rigorous and complete traffic signal warrant analysis by the responsible jurisdiction. Consideration of the other signal warrants, which is beyond the scope of this software, may yield different results.

Jess Ranch

Level Of Service Computation Report
2000 HCM Unsignalized (Future Volume Alternative)
Project AM

Intersection #1: Grant Line Rd and I-580 EB

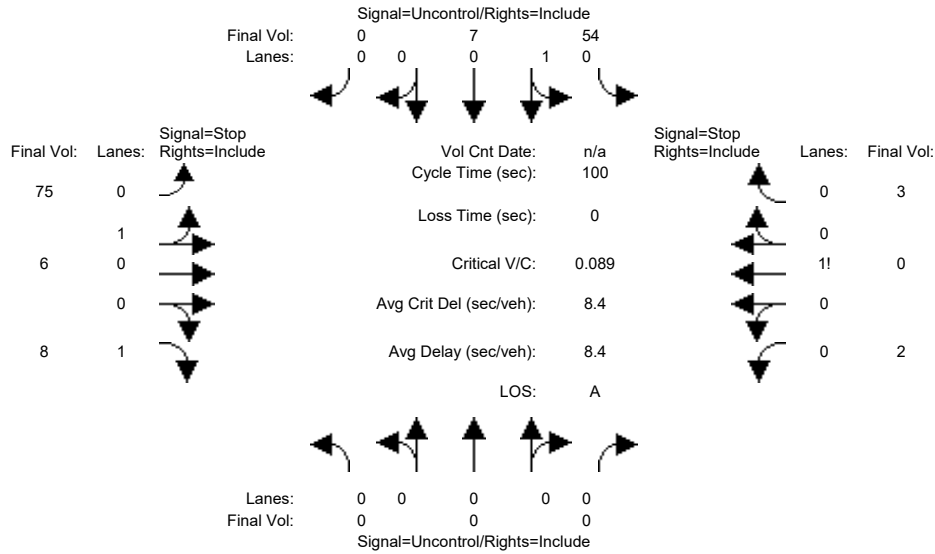

Street Name: Grant Line Road I-580 EB Offramp
 Approach: North Bound South Bound East Bound West Bound
 Movement: L - T - R L - T - R L - T - R L - T - R

Volume Module:												
	North Bound			South Bound			East Bound			West Bound		
	L	T	R	L	T	R	L	T	R	L	T	R
Base Vol:	0	0	0	54	7	0	75	6	8	2	0	3
Growth Adj:	1.00	1.00	1.00	1.00	1.00	1.00	1.00	1.00	1.00	1.00	1.00	1.00
Initial Bse:	0	0	0	54	7	0	75	6	8	2	0	3
Added Vol:	0	0	0	0	0	0	0	0	0	0	0	0
PasserByVol:	0	0	0	0	0	0	0	0	0	0	0	0
Initial Fut:	0	0	0	54	7	0	75	6	8	2	0	3
User Adj:	1.00	1.00	1.00	1.00	1.00	1.00	1.00	1.00	1.00	1.00	1.00	1.00
PHF Adj:	1.00	1.00	1.00	1.00	1.00	1.00	1.00	1.00	1.00	1.00	1.00	1.00
PHF Volume:	0	0	0	54	7	0	75	6	8	2	0	3
Reduct Vol:	0	0	0	0	0	0	0	0	0	0	0	0
FinalVolume:	0	0	0	54	7	0	75	6	8	2	0	3

Critical Gap Module:												
Critical Gp:	xxxxx	xxxx	xxxxx	4.1	xxxx	xxxxx	7.1	6.5	6.2	7.1	6.5	6.2
FollowUpTim:	xxxxx	xxxx	xxxxx	2.2	xxxx	xxxxx	3.5	4.0	3.3	3.5	4.0	3.3

Capacity Module:												
Cnflct Vol:	xxxx	xxxx	xxxxx	0	xxxx	xxxxx	115	115	7	122	115	0
Potent Cap.:	xxxx	xxxx	xxxxx	1636	xxxx	xxxxx	867	779	1081	858	779	1091
Move Cap.:	xxxx	xxxx	xxxxx	1636	xxxx	xxxxx	842	752	1081	824	752	1091
Volume/Cap:	xxxx	xxxx	xxxx	0.03	xxxx	xxxx	0.09	0.01	0.01	0.00	0.00	0.00

Level Of Service Module:												
2Way95thQ:	xxxx	xxxx	xxxxx	0.1	xxxx	xxxxx	xxxx	xxxx	0.0	xxxx	xxxx	xxxxx
Control Del:	xxxxx	xxxx	xxxxx	7.3	xxxx	xxxxx	xxxxx	xxxx	8.4	xxxxx	xxxx	xxxxx
LOS by Move:	*	*	*	A	*	*	*	*	A	*	*	*
Movement:	LT	LTR	RT	LT	LTR	RT	LT	LTR	RT	LT	LTR	RT
Shared Cap.:	xxxx	xxxx	xxxxx	xxxx	xxxx	xxxxx	834	xxxx	xxxxx	xxxx	966	xxxxx
SharedQueue:	xxxxx	xxxx	xxxxx	0.1	xxxx	xxxxx	0.3	xxxx	xxxxx	xxxxx	0.0	xxxxx
Shrd ConDel:	xxxxx	xxxx	xxxxx	7.3	xxxx	xxxxx	9.8	xxxx	xxxxx	xxxxx	8.7	xxxxx
Shared LOS:	*	*	*	A	*	*	A	*	*	*	A	*
ApproachDel:	xxxxxxx			xxxxxxx			9.6			8.7		
ApproachLOS:	*			*			A			A		

Note: Queue reported is the number of cars per lane.

Peak Hour Delay Signal Warrant Report

Intersection #1 Grant Line Rd and I-580 EB

Future Volume Alternative: Peak Hour Warrant NOT Met

Approach:	North Bound	South Bound	East Bound	West Bound
Movement:	L - T - R	L - T - R	L - T - R	L - T - R
Control:	Uncontrolled	Uncontrolled	Stop Sign	Stop Sign
Lanes:	0 0 0 0 0	0 1 0 0 0	0 1 0 0 1	0 0 1! 0 0
Initial Vol:	0 0 0	54 7 0	75 6 8	2 0 3
ApproachDel:	xxxxxxx	xxxxxxx	9.6	8.7

Approach[eastbound][lanes=2][control=Stop Sign]
 Signal Warrant Rule #1: [vehicle-hours=0.2]
 FAIL - Vehicle-hours less than 5 for two or more lane approach.
 Signal Warrant Rule #2: [approach volume=89]
 FAIL - Approach volume less than 150 for two or more lane approach.
 Signal Warrant Rule #3: [approach count=3][total volume=155]
 FAIL - Total volume less than 650 for intersection
 with less than four approaches.

Approach[westbound][lanes=1][control=Stop Sign]
 Signal Warrant Rule #1: [vehicle-hours=0.0]
 FAIL - Vehicle-hours less than 4 for one lane approach.
 Signal Warrant Rule #2: [approach volume=5]
 FAIL - Approach volume less than 100 for one lane approach.
 Signal Warrant Rule #3: [approach count=3][total volume=155]
 FAIL - Total volume less than 650 for intersection
 with less than four approaches.

SIGNAL WARRANT DISCLAIMER
 This peak hour signal warrant analysis should be considered solely as an "indicator" of the likelihood of an unsignalized intersection warranting a traffic signal in the future. Intersections that exceed this warrant are probably more likely to meet one or more of the other volume based signal warrant (such as the 4-hour or 8-hour warrants).

The peak hour warrant analysis in this report is not intended to replace a rigorous and complete traffic signal warrant analysis by the responsible jurisdiction. Consideration of the other signal warrants, which is beyond the scope of this software, may yield different results.

Peak Hour Volume Signal Warrant Report [Urban]

 Intersection #1 Grant Line Rd and I-580 EB

Future Volume Alternative: Peak Hour Warrant NOT Met

Approach:	North Bound	South Bound	East Bound	West Bound
Movement:	L - T - R	L - T - R	L - T - R	L - T - R
Control:	Uncontrolled	Uncontrolled	Stop Sign	Stop Sign
Lanes:	0 0 0 0 0	0 1 0 0 0	0 1 0 0 1	0 0 1! 0 0
Initial Vol:	0 0 0	54 7 0	75 6 8	2 0 3
Major Street Volume:	61			
Minor Approach Volume:	89			
Minor Approach Volume Threshold:	1173			

SIGNAL WARRANT DISCLAIMER
 This peak hour signal warrant analysis should be considered solely as an "indicator" of the likelihood of an unsignalized intersection warranting a traffic signal in the future. Intersections that exceed this warrant are probably more likely to meet one or more of the other volume based signal warrant (such as the 4-hour or 8-hour warrants).

The peak hour warrant analysis in this report is not intended to replace a rigorous and complete traffic signal warrant analysis by the responsible jurisdiction. Consideration of the other signal warrants, which is beyond the scope of this software, may yield different results.

Jess Ranch

Level Of Service Computation Report
2000 HCM Unsignalized (Future Volume Alternative)
Project PM

Intersection #1: Grant Line Rd and I-580 EB

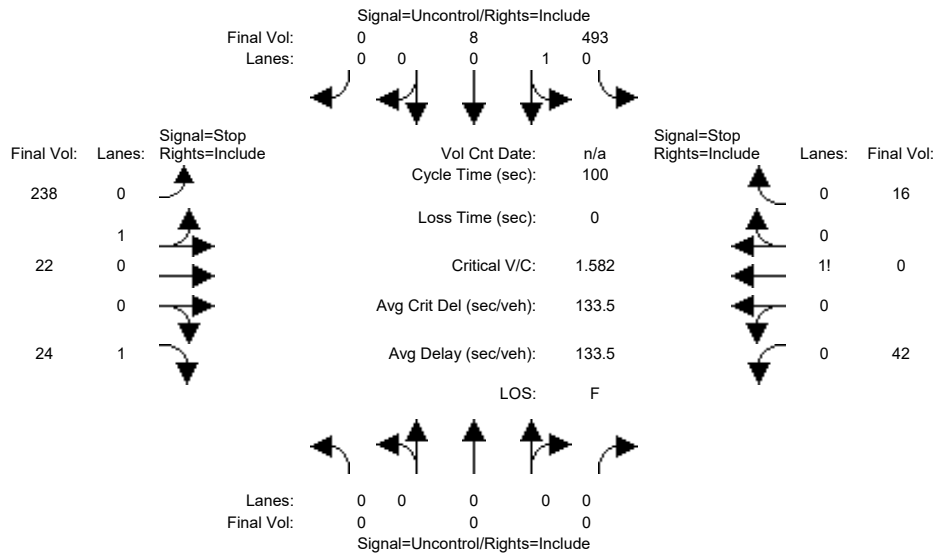

Street Name: Grant Line Road I-580 EB Offramp
 Approach: North Bound South Bound East Bound West Bound
 Movement: L - T - R L - T - R L - T - R L - T - R

Volume Module:												
	North Bound			South Bound			East Bound			West Bound		
	L	T	R	L	T	R	L	T	R	L	T	R
Base Vol:	0	0	0	493	8	0	238	22	24	42	0	16
Growth Adj:	1.00	1.00	1.00	1.00	1.00	1.00	1.00	1.00	1.00	1.00	1.00	1.00
Initial Bse:	0	0	0	493	8	0	238	22	24	42	0	16
Added Vol:	0	0	0	0	0	0	0	0	0	0	0	0
PasserByVol:	0	0	0	0	0	0	0	0	0	0	0	0
Initial Fut:	0	0	0	493	8	0	238	22	24	42	0	16
User Adj:	1.00	1.00	1.00	1.00	1.00	1.00	1.00	1.00	1.00	1.00	1.00	1.00
PHF Adj:	1.00	1.00	1.00	1.00	1.00	1.00	1.00	1.00	1.00	1.00	1.00	1.00
PHF Volume:	0	0	0	493	8	0	238	22	24	42	0	16
Reduct Vol:	0	0	0	0	0	0	0	0	0	0	0	0
FinalVolume:	0	0	0	493	8	0	238	22	24	42	0	16

Critical Gap Module:												
Critical Gp:	xxxxx	xxxx	xxxxx	4.1	xxxx	xxxxxx	7.1	6.5	6.2	7.1	6.5	6.2
FollowUpTim:	xxxxx	xxxx	xxxxx	2.2	xxxx	xxxxxx	3.5	4.0	3.3	3.5	4.0	3.3

Capacity Module:												
Cnflct Vol:	xxxx	xxxx	xxxxx	0	xxxx	xxxxxx	994	994	8	1017	994	0
Potent Cap.:	xxxx	xxxx	xxxxx	1636	xxxx	xxxxxx	226	247	1080	218	247	1091
Move Cap.:	xxxx	xxxx	xxxxx	1636	xxxx	xxxxxx	150	145	1080	129	145	1091
Volume/Cap:	xxxx	xxxx	xxxx	0.30	xxxx	xxxxxx	1.58	0.15	0.02	0.33	0.00	0.01

Level Of Service Module:												
2Way95thQ:	xxxx	xxxx	xxxxx	1.3	xxxx	xxxxxx	xxxx	xxxx	0.1	xxxx	xxxx	xxxxx
Control Del:	xxxxx	xxxx	xxxxx	8.1	xxxx	xxxxxx	xxxxxx	xxxx	8.4	xxxxxx	xxxx	xxxxxx
LOS by Move:	*	*	*	A	*	*	*	*	A	*	*	*
Movement:	LT	LTR	RT	LT	LTR	RT	LT	LTR	RT	LT	LTR	RT
Shared Cap.:	xxxx	xxxx	xxxxx	xxxx	xxxx	xxxxxx	150	xxxx	xxxxxx	xxxx	170	xxxxxx
SharedQueue:	xxxxx	xxxx	xxxxx	1.3	xxxx	xxxxxx	18.9	xxxx	xxxxxx	xxxxxx	1.4	xxxxxx
Shrd ConDel:	xxxxx	xxxx	xxxxx	8.1	xxxx	xxxxxx	408.6	xxxx	xxxxxx	xxxxxx	36.8	xxxxxx
Shared LOS:	*	*	*	A	*	*	F	*	*	*	E	*
ApproachDel:	xxxxxxx			xxxxxxx			374.7			36.8		
ApproachLOS:	*			*			F			E		

Note: Queue reported is the number of cars per lane.

Peak Hour Delay Signal Warrant Report

Intersection #1 Grant Line Rd and I-580 EB

Future Volume Alternative: Peak Hour Warrant Met

Approach:	North Bound	South Bound	East Bound	West Bound
Movement:	L - T - R	L - T - R	L - T - R	L - T - R
Control:	Uncontrolled	Uncontrolled	Stop Sign	Stop Sign
Lanes:	0 0 0 0 0	0 1 0 0 0	0 1 0 0 1	0 0 1! 0 0
Initial Vol:	0 0 0	493 8 0	238 22 24	42 0 16
ApproachDel:	xxxxxxx	xxxxxxx	374.7	36.8

Approach[eastbound][lanes=2][control=Stop Sign]
Signal Warrant Rule #1: [vehicle-hours=29.6]
SUCCEED - Vehicle-hours >= 5 for two or more lane approach.
Signal Warrant Rule #2: [approach volume=284]
SUCCEED - Approach volume >= 150 for two or more lane approach.
Signal Warrant Rule #3: [approach count=3][total volume=843]
SUCCEED - Total volume greater than or equal to 650 for intersection with less than four approaches.

Approach[westbound][lanes=1][control=Stop Sign]
Signal Warrant Rule #1: [vehicle-hours=0.6]
FAIL - Vehicle-hours less than 4 for one lane approach.
Signal Warrant Rule #2: [approach volume=58]
FAIL - Approach volume less than 100 for one lane approach.
Signal Warrant Rule #3: [approach count=3][total volume=843]
SUCCEED - Total volume greater than or equal to 650 for intersection with less than four approaches.

SIGNAL WARRANT DISCLAIMER
This peak hour signal warrant analysis should be considered solely as an "indicator" of the likelihood of an unsignalized intersection warranting a traffic signal in the future. Intersections that exceed this warrant are probably more likely to meet one or more of the other volume based signal warrant (such as the 4-hour or 8-hour warrants).

The peak hour warrant analysis in this report is not intended to replace a rigorous and complete traffic signal warrant analysis by the responsible jurisdiction. Consideration of the other signal warrants, which is beyond the scope of this software, may yield different results.

Peak Hour Volume Signal Warrant Report [Urban]

Intersection #1 Grant Line Rd and I-580 EB

Future Volume Alternative: Peak Hour Warrant NOT Met

Approach:	North Bound	South Bound	East Bound	West Bound
Movement:	L - T - R	L - T - R	L - T - R	L - T - R
Control:	Uncontrolled	Uncontrolled	Stop Sign	Stop Sign
Lanes:	0 0 0 0 0	0 1 0 0 0	0 1 0 0 1	0 0 1! 0 0
Initial Vol:	0 0 0	493 8 0	238 22 24	42 0 16
Major Street Volume:	501			
Minor Approach Volume:	284			
Minor Approach Volume Threshold:	510			

SIGNAL WARRANT DISCLAIMER
This peak hour signal warrant analysis should be considered solely as an "indicator" of the likelihood of an unsignalized intersection warranting a traffic signal in the future. Intersections that exceed this warrant are probably more likely to meet one or more of the other volume based signal warrant (such as the 4-hour or 8-hour warrants).

The peak hour warrant analysis in this report is not intended to replace a rigorous and complete traffic signal warrant analysis by the responsible jurisdiction. Consideration of the other signal warrants, which is beyond the scope of this software, may yield different results.

Jess Ranch

Level Of Service Computation Report
2000 HCM Unsignalized (Future Volume Alternative)
Existing AM

Intersection #2: Grant Line Rd and I-580 WB

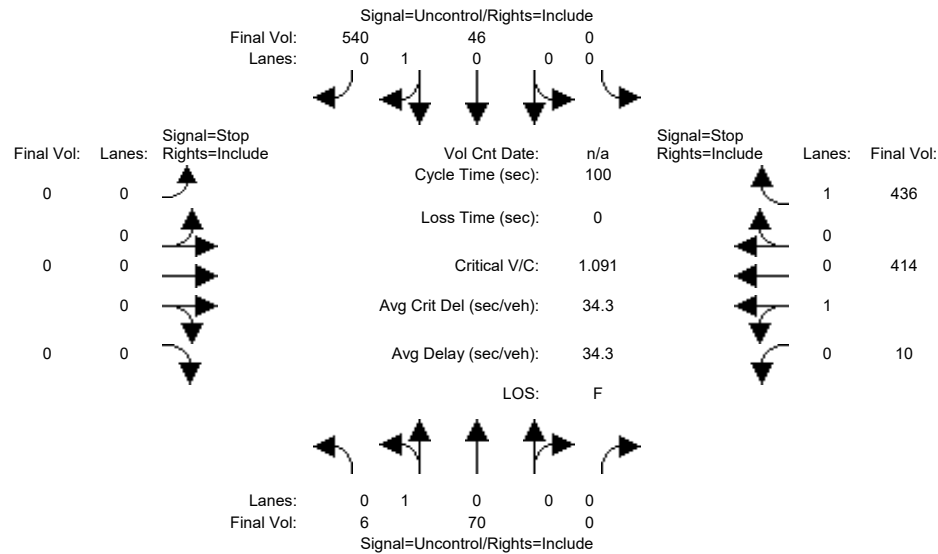

Street Name: Grant Line Road I-580 WB Offramp
 Approach: North Bound South Bound East Bound West Bound
 Movement: L - T - R L - T - R L - T - R L - T - R

Volume Module:

Base Vol:	6	70	0	0	46	540	0	0	0	10	414	436
Growth Adj:	1.00	1.00	1.00	1.00	1.00	1.00	1.00	1.00	1.00	1.00	1.00	1.00
Initial Bse:	6	70	0	0	46	540	0	0	0	10	414	436
Added Vol:	0	0	0	0	0	0	0	0	0	0	0	0
PasserByVol:	0	0	0	0	0	0	0	0	0	0	0	0
Initial Fut:	6	70	0	0	46	540	0	0	0	10	414	436
User Adj:	1.00	1.00	1.00	1.00	1.00	1.00	1.00	1.00	1.00	1.00	1.00	1.00
PHF Adj:	1.00	1.00	1.00	1.00	1.00	1.00	1.00	1.00	1.00	1.00	1.00	1.00
PHF Volume:	6	70	0	0	46	540	0	0	0	10	414	436
Reduct Vol:	0	0	0	0	0	0	0	0	0	0	0	0
FinalVolume:	6	70	0	0	46	540	0	0	0	10	414	436

Critical Gap Module:

Critical Gp:	4.1	xxxx	xxxxxx	xxxxxx	xxxx	xxxxxx	xxxxxx	xxxx	xxxxxx	6.4	6.5	6.2
FollowUpTim:	2.2	xxxx	xxxxxx	xxxxxx	xxxx	xxxxxx	xxxxxx	xxxx	xxxxxx	3.5	4.0	3.3

Capacity Module:

Cnflct Vol:	586	xxxx	xxxxxx	xxxxxx	xxxx	xxxxxx	xxxxxx	xxxx	xxxxxx	398	668	70
Potent Cap.:	999	xxxx	xxxxxx	xxxxxx	xxxx	xxxxxx	xxxxxx	xxxx	xxxxxx	611	382	998
Move Cap.:	999	xxxx	xxxxxx	xxxxxx	xxxx	xxxxxx	xxxxxx	xxxx	xxxxxx	609	379	998
Volume/Cap:	0.01	xxxx	xxxxxx	xxxxxx	xxxx	xxxxxx	xxxxxx	xxxx	xxxxxx	0.02	1.09	0.44

Level Of Service Module:

2Way95thQ:	0.0	xxxx	xxxxxx	xxxxxx	xxxx	xxxxxx	xxxxxx	xxxx	xxxxxx	xxxx	xxxx	2.3
Control Del:	8.6	xxxx	xxxxxx	xxxxxx	xxxx	xxxxxx	xxxxxx	xxxx	xxxxxx	xxxxxx	xxxx	11.4
LOS by Move:	A	*	*	*	*	*	*	*	*	*	*	B
Movement:	LT - LTR - RT	LT - LTR - RT	LT - LTR - RT	LT - LTR - RT	LT - LTR - RT	LT - LTR - RT	LT - LTR - RT	LT - LTR - RT	LT - LTR - RT	LT - LTR - RT	LT - LTR - RT	
Shared Cap.:	xxxx	xxxx	xxxxxx	xxxxxx	xxxx	xxxxxx	xxxxxx	xxxx	xxxxxx	383	xxxx	xxxxxx
SharedQueue:	0.0	xxxx	xxxxxx	xxxxxx	xxxx	xxxxxx	xxxxxx	xxxx	xxxxxx	15.4	xxxx	xxxxxx
Shrd ConDel:	8.6	xxxx	xxxxxx	xxxxxx	xxxx	xxxxxx	xxxxxx	xxxx	xxxxxx	111.3	xxxx	xxxxxx
Shared LOS:	A	*	*	*	*	*	*	*	*	F	*	*
ApproachDel:	xxxxxxx				xxxxxxx			xxxxxxx				60.6
ApproachLOS:	*				*			*				F

Note: Queue reported is the number of cars per lane.
 Peak Hour Delay Signal Warrant Report

 Intersection #2 Grant Line Rd and I-580 WB

 Future Volume Alternative: Peak Hour Warrant Met

Approach:	North Bound	South Bound	East Bound	West Bound
Movement:	L - T - R	L - T - R	L - T - R	L - T - R
Control:	Uncontrolled	Uncontrolled	Stop Sign	Stop Sign
Lanes:	0 1 0 0 0	0 0 0 1 0	0 0 0 0 0	0 1 0 0 1
Initial Vol:	6 70 0	0 46 540	0 0 0	10 414 436
ApproachDel:	xxxxxxx	xxxxxxx	xxxxxxx	60.6

Approach[westbound][lanes=2][control=Stop Sign]
Signal Warrant Rule #1: [vehicle-hours=14.5]
SUCCEED - Vehicle-hours >= 5 for two or more lane approach.
Signal Warrant Rule #2: [approach volume=860]
SUCCEED - Approach volume >= 150 for two or more lane approach.
Signal Warrant Rule #3: [approach count=3][total volume=1522]
SUCCEED - Total volume greater than or equal to 650 for intersection with less than four approaches.

SIGNAL WARRANT DISCLAIMER

This peak hour signal warrant analysis should be considered solely as an "indicator" of the likelihood of an unsignalized intersection warranting a traffic signal in the future. Intersections that exceed this warrant are probably more likely to meet one or more of the other volume based signal warrant (such as the 4-hour or 8-hour warrants).

The peak hour warrant analysis in this report is not intended to replace a rigorous and complete traffic signal warrant analysis by the responsible jurisdiction. Consideration of the other signal warrants, which is beyond the scope of this software, may yield different results.

Peak Hour Volume Signal Warrant Report [Urban]

Intersection #2 Grant Line Rd and I-580 WB

Future Volume Alternative: Peak Hour Warrant Met

Approach:	North Bound	South Bound	East Bound	West Bound
Movement:	L - T - R	L - T - R	L - T - R	L - T - R
Control:	Uncontrolled	Uncontrolled	Stop Sign	Stop Sign
Lanes:	0 1 0 0 0	0 0 0 1 0	0 0 0 0 0	0 1 0 0 1
Initial Vol:	6 70 0	0 46 540	0 0 0	10 414 436

Major Street Volume: 662
Minor Approach Volume: 860
Minor Approach Volume Threshold: 422

SIGNAL WARRANT DISCLAIMER

This peak hour signal warrant analysis should be considered solely as an "indicator" of the likelihood of an unsignalized intersection warranting a traffic signal in the future. Intersections that exceed this warrant are probably more likely to meet one or more of the other volume based signal warrant (such as the 4-hour or 8-hour warrants).

The peak hour warrant analysis in this report is not intended to replace a rigorous and complete traffic signal warrant analysis by the responsible jurisdiction. Consideration of the other signal warrants, which is beyond the scope of this software, may yield different results.

Jess Ranch

Level Of Service Computation Report
2000 HCM Unsignalized (Future Volume Alternative)
Existing PM

Intersection #2: Grant Line Rd and I-580 WB

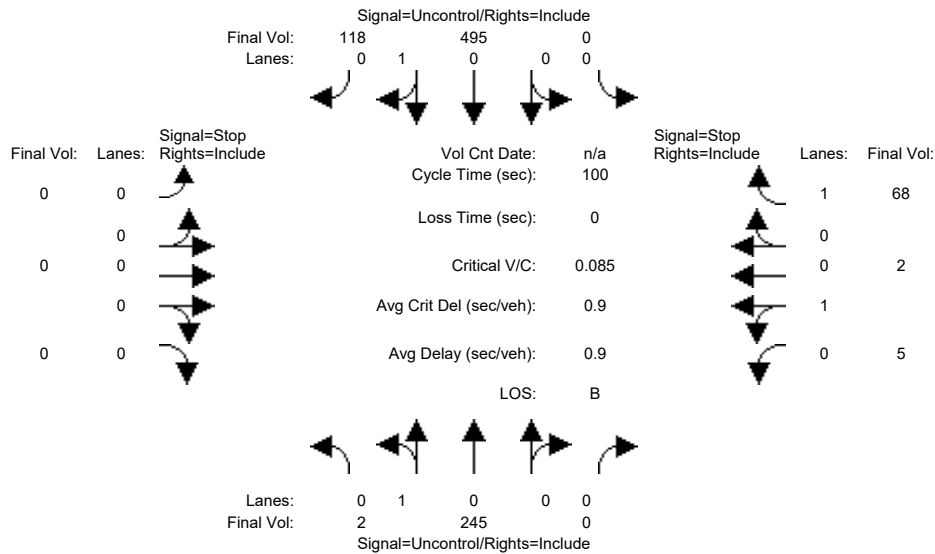

Street Name: Grant Line Road I-580 WB Offramp
 Approach: North Bound South Bound East Bound West Bound
 Movement: L - T - R L - T - R L - T - R L - T - R

Volume Module:	North Bound		South Bound		East Bound			West Bound				
Base Vol:	2	245	0	0	495	118	0	0	0	5	2	68
Growth Adj:	1.00	1.00	1.00	1.00	1.00	1.00	1.00	1.00	1.00	1.00	1.00	1.00
Initial Bse:	2	245	0	0	495	118	0	0	0	5	2	68
Added Vol:	0	0	0	0	0	0	0	0	0	0	0	0
PasserByVol:	0	0	0	0	0	0	0	0	0	0	0	0
Initial Fut:	2	245	0	0	495	118	0	0	0	5	2	68
User Adj:	1.00	1.00	1.00	1.00	1.00	1.00	1.00	1.00	1.00	1.00	1.00	1.00
PHF Adj:	1.00	1.00	1.00	1.00	1.00	1.00	1.00	1.00	1.00	1.00	1.00	1.00
PHF Volume:	2	245	0	0	495	118	0	0	0	5	2	68
Reduct Vol:	0	0	0	0	0	0	0	0	0	0	0	0
FinalVolume:	2	245	0	0	495	118	0	0	0	5	2	68

Critical Gap Module:	North Bound		South Bound		East Bound			West Bound				
Critical Gp:	4.1	xxxx	xxxxxx	xxxxxx	xxxx	xxxxxx	xxxxxx	xxxx	xxxxxx	6.4	6.5	6.2
FollowUpTim:	2.2	xxxx	xxxxxx	xxxxxx	xxxx	xxxxxx	xxxxxx	xxxx	xxxxxx	3.5	4.0	3.3

Capacity Module:	North Bound		South Bound		East Bound			West Bound				
Cnflct Vol:	613	xxxx	xxxxxx	xxxx	xxxx	xxxxxx	xxxx	xxxx	xxxxxx	803	862	245
Potent Cap.:	976	xxxx	xxxxxx	xxxx	xxxx	xxxxxx	xxxx	xxxx	xxxxxx	355	295	799
Move Cap.:	976	xxxx	xxxxxx	xxxx	xxxx	xxxxxx	xxxx	xxxx	xxxxxx	355	294	799
Volume/Cap:	0.00	xxxx	xxxx	xxxx	xxxx	xxxx	xxxx	xxxx	xxxx	0.01	0.01	0.09

Level Of Service Module:	North Bound		South Bound		East Bound			West Bound				
2Way95thQ:	0.0	xxxx	xxxxxx	xxxx	xxxx	xxxxxx	xxxx	xxxx	xxxxxx	xxxx	xxxx	0.3
Control Del:	8.7	xxxx	xxxxxx	xxxxxx	xxxx	xxxxxx	xxxxxx	xxxx	xxxxxx	xxxxxx	xxxx	9.9
LOS by Move:	A	*	*	*	*	*	*	*	*	*	*	A
Movement:	LT - LTR - RT	LT - LTR - RT	LT - LTR - RT	LT - LTR - RT	LT - LTR - RT	LT - LTR - RT	LT - LTR - RT	LT - LTR - RT	LT - LTR - RT	LT - LTR - RT	LT - LTR - RT	
Shared Cap.:	xxxx	xxxx	xxxxxx	xxxx	xxxx	xxxxxx	xxxx	xxxx	xxxxxx	335	xxxx	xxxxxx
SharedQueue:	0.0	xxxx	xxxxxx	xxxxxx	xxxx	xxxxxx	xxxxxx	xxxx	xxxxxx	0.1	xxxx	xxxxxx
Shrd ConDel:	8.7	xxxx	xxxxxx	xxxxxx	xxxx	xxxxxx	xxxxxx	xxxx	xxxxxx	16.0	xxxx	xxxxxx
Shared LOS:	A	*	*	*	*	*	*	*	*	C	*	*
ApproachDel:	xxxxxxx			xxxxxxx			xxxxxxx			10.5		
ApproachLOS:	*			*			*			B		

Note: Queue reported is the number of cars per lane.

Peak Hour Delay Signal Warrant Report

Intersection #2 Grant Line Rd and I-580 WB

Future Volume Alternative: Peak Hour Warrant NOT Met

Approach:	North Bound	South Bound	East Bound	West Bound
Movement:	L - T - R	L - T - R	L - T - R	L - T - R
Control:	Uncontrolled	Uncontrolled	Stop Sign	Stop Sign
Lanes:	0 1 0 0 0	0 0 0 1 0	0 0 0 0 0	0 1 0 0 1
Initial Vol:	2 245 0	0 495 118	0 0 0 0	5 2 68
ApproachDel:	xxxxxx	xxxxxx	xxxxxx	10.5

Approach[westbound][lanes=2][control=Stop Sign]

Signal Warrant Rule #1: [vehicle-hours=0.2]

FAIL - Vehicle-hours less than 5 for two or more lane approach.

Signal Warrant Rule #2: [approach volume=75]

FAIL - Approach volume less than 150 for two or more lane approach.

Signal Warrant Rule #3: [approach count=3][total volume=935]

SUCCEED - Total volume greater than or equal to 650 for intersection with less than four approaches.

SIGNAL WARRANT DISCLAIMER

This peak hour signal warrant analysis should be considered solely as an "indicator" of the likelihood of an unsignalized intersection warranting a traffic signal in the future. Intersections that exceed this warrant are probably more likely to meet one or more of the other volume based signal warrant (such as the 4-hour or 8-hour warrants).

The peak hour warrant analysis in this report is not intended to replace a rigorous and complete traffic signal warrant analysis by the responsible jurisdiction. Consideration of the other signal warrants, which is beyond the scope of this software, may yield different results.

Peak Hour Volume Signal Warrant Report [Urban]

Intersection #2 Grant Line Rd and I-580 WB

Future Volume Alternative: Peak Hour Warrant NOT Met

Approach:	North Bound	South Bound	East Bound	West Bound
Movement:	L - T - R	L - T - R	L - T - R	L - T - R
Control:	Uncontrolled	Uncontrolled	Stop Sign	Stop Sign
Lanes:	0 1 0 0 0	0 0 0 1 0	0 0 0 0 0	0 1 0 0 1
Initial Vol:	2 245 0	0 495 118	0 0 0 0	5 2 68

Major Street Volume: 860

Minor Approach Volume: 75

Minor Approach Volume Threshold: 340

SIGNAL WARRANT DISCLAIMER

This peak hour signal warrant analysis should be considered solely as an "indicator" of the likelihood of an unsignalized intersection warranting a traffic signal in the future. Intersections that exceed this warrant are probably more likely to meet one or more of the other volume based signal warrant (such as the 4-hour or 8-hour warrants).

The peak hour warrant analysis in this report is not intended to replace a rigorous and complete traffic signal warrant analysis by the responsible jurisdiction. Consideration of the other signal warrants, which is beyond the scope of this software, may yield different results.

Jess Ranch

Level Of Service Computation Report
2000 HCM Unsignalized (Future Volume Alternative)
Project AM

Intersection #2: Grant Line Rd and I-580 WB

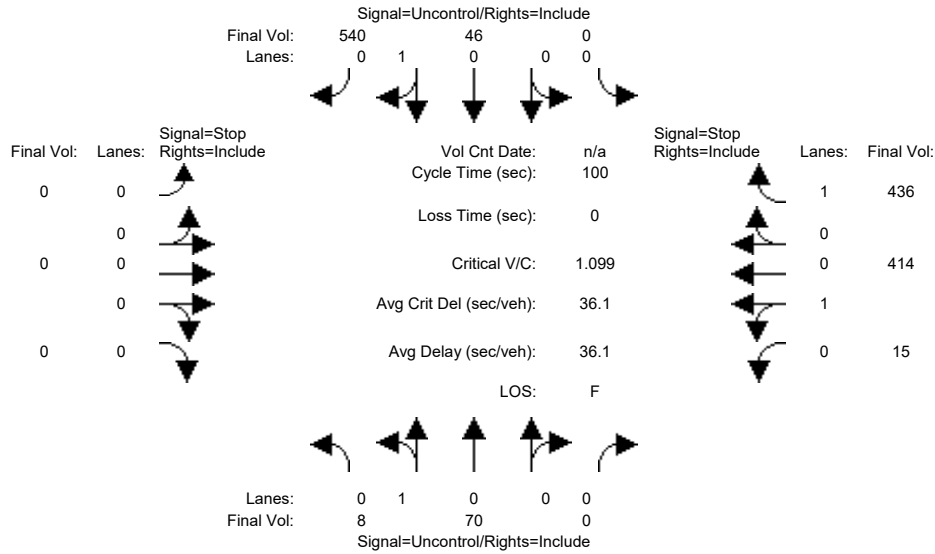

Street Name: Grant Line Road I-580 WB Offramp
 Approach: North Bound South Bound East Bound West Bound
 Movement: L - T - R L - T - R L - T - R L - T - R

Volume Module:	North Bound		South Bound		East Bound			West Bound				
Base Vol:	8	70	0	0	46	540	0	0	0	15	414	436
Growth Adj:	1.00	1.00	1.00	1.00	1.00	1.00	1.00	1.00	1.00	1.00	1.00	1.00
Initial Bse:	8	70	0	0	46	540	0	0	0	15	414	436
Added Vol:	0	0	0	0	0	0	0	0	0	0	0	0
PasserByVol:	0	0	0	0	0	0	0	0	0	0	0	0
Initial Fut:	8	70	0	0	46	540	0	0	0	15	414	436
User Adj:	1.00	1.00	1.00	1.00	1.00	1.00	1.00	1.00	1.00	1.00	1.00	1.00
PHF Adj:	1.00	1.00	1.00	1.00	1.00	1.00	1.00	1.00	1.00	1.00	1.00	1.00
PHF Volume:	8	70	0	0	46	540	0	0	0	15	414	436
Reduct Vol:	0	0	0	0	0	0	0	0	0	0	0	0
FinalVolume:	8	70	0	0	46	540	0	0	0	15	414	436

Critical Gap Module:	North Bound		South Bound		East Bound			West Bound				
Critical Gp:	4.1	xxxx	xxxxxx	xxxxxx	xxxx	xxxxxx	xxxxxx	xxxx	xxxxxx	6.4	6.5	6.2
FollowUpTim:	2.2	xxxx	xxxxxx	xxxxxx	xxxx	xxxxxx	xxxxxx	xxxx	xxxxxx	3.5	4.0	3.3

Capacity Module:	North Bound		South Bound		East Bound			West Bound				
Cnflct Vol:	586	xxxx	xxxxxx	xxxx	xxxx	xxxxxx	xxxx	xxxx	xxxxxx	402	672	70
Potent Cap.:	999	xxxx	xxxxxx	xxxx	xxxx	xxxxxx	xxxx	xxxx	xxxxxx	608	380	998
Move Cap.:	999	xxxx	xxxxxx	xxxx	xxxx	xxxxxx	xxxx	xxxx	xxxxxx	604	377	998
Volume/Cap:	0.01	xxxx	xxxx	xxxx	xxxx	xxxx	xxxx	xxxx	xxxx	0.02	1.10	0.44

Level Of Service Module:	North Bound		South Bound		East Bound			West Bound				
2Way95thQ:	0.0	xxxx	xxxxxx	xxxx	xxxx	xxxxxx	xxxx	xxxx	xxxxxx	xxxx	xxxx	2.3
Control Del:	8.6	xxxx	xxxxxx	xxxxxx	xxxx	xxxxxx	xxxxxx	xxxx	xxxxxx	xxxxxx	xxxx	11.4
LOS by Move:	A	*	*	*	*	*	*	*	*	*	*	B
Shared Cap.:	xxxx	xxxx	xxxxxx	xxxx	xxxx	xxxxxx	xxxx	xxxx	xxxxxx	382	xxxx	xxxxxx
SharedQueue:	0.0	xxxx	xxxxxx	xxxxxx	xxxx	xxxxxx	xxxxxx	xxxx	xxxxxx	16.0	xxxx	xxxxxx
Shrd ConDel:	8.6	xxxx	xxxxxx	xxxxxx	xxxx	xxxxxx	xxxxxx	xxxx	xxxxxx	116.9	xxxx	xxxxxx
Shared LOS:	A	*	*	*	*	*	*	*	*	F	*	*
ApproachDel:	xxxxxxx			xxxxxxx			xxxxxxx			63.7		
ApproachLOS:	*			*			*			F		

Note: Queue reported is the number of cars per lane.

Peak Hour Delay Signal Warrant Report

 Intersection #2 Grant Line Rd and I-580 WB

 Future Volume Alternative: Peak Hour Warrant Met

Approach:	North Bound	South Bound	East Bound	West Bound
Movement:	L - T - R	L - T - R	L - T - R	L - T - R
Control:	Uncontrolled	Uncontrolled	Stop Sign	Stop Sign
Lanes:	0 1 0 0 0	0 0 0 1 0	0 0 0 0 0	0 1 0 0 1
Initial Vol:	8 70 0	0 46 540	0 0 0	15 414 436
ApproachDel:	xxxxxx	xxxxxx	xxxxxx	63.7

Approach[westbound][lanes=2][control=Stop Sign]
 Signal Warrant Rule #1: [vehicle-hours=15.3]
 SUCCEED - Vehicle-hours >= 5 for two or more lane approach.
 Signal Warrant Rule #2: [approach volume=865]
 SUCCEED - Approach volume >= 150 for two or more lane approach.
 Signal Warrant Rule #3: [approach count=3][total volume=1529]
 SUCCEED - Total volume greater than or equal to 650 for intersection with less than four approaches.

SIGNAL WARRANT DISCLAIMER

This peak hour signal warrant analysis should be considered solely as an "indicator" of the likelihood of an unsignalized intersection warranting a traffic signal in the future. Intersections that exceed this warrant are probably more likely to meet one or more of the other volume based signal warrant (such as the 4-hour or 8-hour warrants).

The peak hour warrant analysis in this report is not intended to replace a rigorous and complete traffic signal warrant analysis by the responsible jurisdiction. Consideration of the other signal warrants, which is beyond the scope of this software, may yield different results.

Peak Hour Volume Signal Warrant Report [Urban]

 Intersection #2 Grant Line Rd and I-580 WB

Future Volume Alternative: Peak Hour Warrant Met

Approach:	North Bound	South Bound	East Bound	West Bound
Movement:	L - T - R	L - T - R	L - T - R	L - T - R
Control:	Uncontrolled	Uncontrolled	Stop Sign	Stop Sign
Lanes:	0 1 0 0 0	0 0 0 1 0	0 0 0 0 0	0 1 0 0 1
Initial Vol:	8 70 0	0 46 540	0 0 0	15 414 436

Major Street Volume: 664
 Minor Approach Volume: 865
 Minor Approach Volume Threshold: 421

SIGNAL WARRANT DISCLAIMER

This peak hour signal warrant analysis should be considered solely as an "indicator" of the likelihood of an unsignalized intersection warranting a traffic signal in the future. Intersections that exceed this warrant are probably more likely to meet one or more of the other volume based signal warrant (such as the 4-hour or 8-hour warrants).

The peak hour warrant analysis in this report is not intended to replace a rigorous and complete traffic signal warrant analysis by the responsible jurisdiction. Consideration of the other signal warrants, which is beyond the scope of this software, may yield different results.

Jess Ranch

Level Of Service Computation Report
2000 HCM Unsignalized (Future Volume Alternative)
Project PM

Intersection #2: Grant Line Rd and I-580 WB

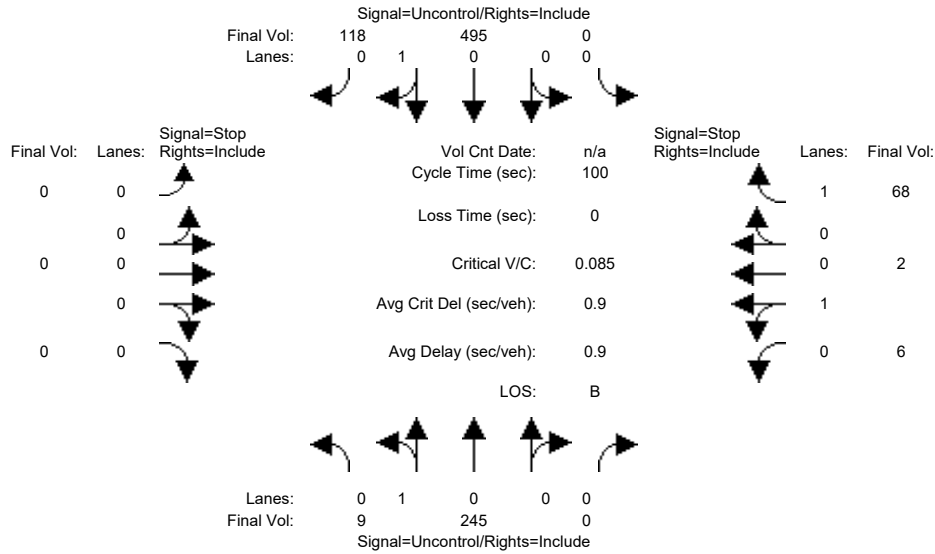

Street Name: Grant Line Road I-580 WB Offramp
 Approach: North Bound South Bound East Bound West Bound
 Movement: L - T - R L - T - R L - T - R L - T - R

Volume Module:												
Base Vol:	9	245	0	0	495	118	0	0	0	6	2	68
Growth Adj:	1.00	1.00	1.00	1.00	1.00	1.00	1.00	1.00	1.00	1.00	1.00	1.00
Initial Bse:	9	245	0	0	495	118	0	0	0	6	2	68
Added Vol:	0	0	0	0	0	0	0	0	0	0	0	0
PasserByVol:	0	0	0	0	0	0	0	0	0	0	0	0
Initial Fut:	9	245	0	0	495	118	0	0	0	6	2	68
User Adj:	1.00	1.00	1.00	1.00	1.00	1.00	1.00	1.00	1.00	1.00	1.00	1.00
PHF Adj:	1.00	1.00	1.00	1.00	1.00	1.00	1.00	1.00	1.00	1.00	1.00	1.00
PHF Volume:	9	245	0	0	495	118	0	0	0	6	2	68
Reduct Vol:	0	0	0	0	0	0	0	0	0	0	0	0
FinalVolume:	9	245	0	0	495	118	0	0	0	6	2	68

Critical Gap Module:												
Critical Gp:	4.1	xxxx	xxxxxx	xxxxxx	xxxx	xxxxxx	xxxxxx	xxxx	xxxxxx	6.4	6.5	6.2
FollowUpTim:	2.2	xxxx	xxxxxx	xxxxxx	xxxx	xxxxxx	xxxxxx	xxxx	xxxxxx	3.5	4.0	3.3

Capacity Module:												
Cnflct Vol:	613	xxxx	xxxxxx	xxxx	xxxx	xxxxxx	xxxx	xxxx	xxxxxx	817	876	245
Potent Cap.:	976	xxxx	xxxxxx	xxxx	xxxx	xxxxxx	xxxx	xxxx	xxxxxx	349	290	799
Move Cap.:	976	xxxx	xxxxxx	xxxx	xxxx	xxxxxx	xxxx	xxxx	xxxxxx	346	287	799
Volume/Cap:	0.01	xxxx	xxxx	xxxx	xxxx	xxxx	xxxx	xxxx	xxxx	0.02	0.01	0.09

Level Of Service Module:												
2Way95thQ:	0.0	xxxx	xxxxxx	xxxx	xxxx	xxxxxx	xxxx	xxxx	xxxxxx	xxxx	xxxx	0.3
Control Del:	8.7	xxxx	xxxxxx	xxxxxx	xxxx	xxxxxx	xxxxxx	xxxx	xxxxxx	xxxxxx	xxxx	9.9
LOS by Move:	A	*	*	*	*	*	*	*	*	*	*	A
Movement:	LT - LTR - RT	LT - LTR - RT	LT - LTR - RT	LT - LTR - RT	LT - LTR - RT	LT - LTR - RT	LT - LTR - RT	LT - LTR - RT	LT - LTR - RT	LT - LTR - RT	LT - LTR - RT	LT - LTR - RT
Shared Cap.:	xxxx	xxxx	xxxxxx	xxxx	xxxx	xxxxxx	xxxx	xxxx	xxxxxx	329	xxxx	xxxxxx
SharedQueue:	0.0	xxxx	xxxxxx	xxxxxx	xxxx	xxxxxx	xxxxxx	xxxx	xxxxxx	0.1	xxxx	xxxxxx
Shrd ConDel:	8.7	xxxx	xxxxxx	xxxxxx	xxxx	xxxxxx	xxxxxx	xxxx	xxxxxx	16.2	xxxx	xxxxxx
Shared LOS:	A	*	*	*	*	*	*	*	*	C	*	*
ApproachDel:	xxxxxxx			xxxxxxx			xxxxxxx			10.6		
ApproachLOS:	*			*			*			B		

Note: Queue reported is the number of cars per lane.

Peak Hour Delay Signal Warrant Report

Intersection #2 Grant Line Rd and I-580 WB

Future Volume Alternative: Peak Hour Warrant NOT Met

Approach:	North Bound	South Bound	East Bound	West Bound
Movement:	L - T - R	L - T - R	L - T - R	L - T - R
Control:	Uncontrolled	Uncontrolled	Stop Sign	Stop Sign
Lanes:	0 1 0 0 0	0 0 0 1 0	0 0 0 0 0	0 1 0 0 1
Initial Vol:	9 245 0	0 495 118	0 0 0 0	6 2 68
ApproachDel:	xxxxxx	xxxxxx	xxxxxx	10.6

Approach[westbound][lanes=2][control=Stop Sign]
 Signal Warrant Rule #1: [vehicle-hours=0.2]
 FAIL - Vehicle-hours less than 5 for two or more lane approach.
 Signal Warrant Rule #2: [approach volume=76]
 FAIL - Approach volume less than 150 for two or more lane approach.
 Signal Warrant Rule #3: [approach count=3][total volume=943]
 SUCCEED - Total volume greater than or equal to 650 for intersection with less than four approaches.

SIGNAL WARRANT DISCLAIMER

This peak hour signal warrant analysis should be considered solely as an "indicator" of the likelihood of an unsignalized intersection warranting a traffic signal in the future. Intersections that exceed this warrant are probably more likely to meet one or more of the other volume based signal warrant (such as the 4-hour or 8-hour warrants).

The peak hour warrant analysis in this report is not intended to replace a rigorous and complete traffic signal warrant analysis by the responsible jurisdiction. Consideration of the other signal warrants, which is beyond the scope of this software, may yield different results.

Peak Hour Volume Signal Warrant Report [Urban]

 Intersection #2 Grant Line Rd and I-580 WB

Future Volume Alternative: Peak Hour Warrant NOT Met

Approach:	North Bound	South Bound	East Bound	West Bound
Movement:	L - T - R	L - T - R	L - T - R	L - T - R
Control:	Uncontrolled	Uncontrolled	Stop Sign	Stop Sign
Lanes:	0 1 0 0 0	0 0 0 1 0	0 0 0 0 0	0 1 0 0 1
Initial Vol:	9 245 0	0 495 118	0 0 0 0	6 2 68

Major Street Volume: 867
 Minor Approach Volume: 76
 Minor Approach Volume Threshold: 337

SIGNAL WARRANT DISCLAIMER

This peak hour signal warrant analysis should be considered solely as an "indicator" of the likelihood of an unsignalized intersection warranting a traffic signal in the future. Intersections that exceed this warrant are probably more likely to meet one or more of the other volume based signal warrant (such as the 4-hour or 8-hour warrants).

The peak hour warrant analysis in this report is not intended to replace a rigorous and complete traffic signal warrant analysis by the responsible jurisdiction. Consideration of the other signal warrants, which is beyond the scope of this software, may yield different results.

Level Of Service Computation Report
 2000 HCM Operations (Future Volume Alternative)
 Cumulative AM Baseline

Intersection #1: Grant Line Rd and I-580 EB

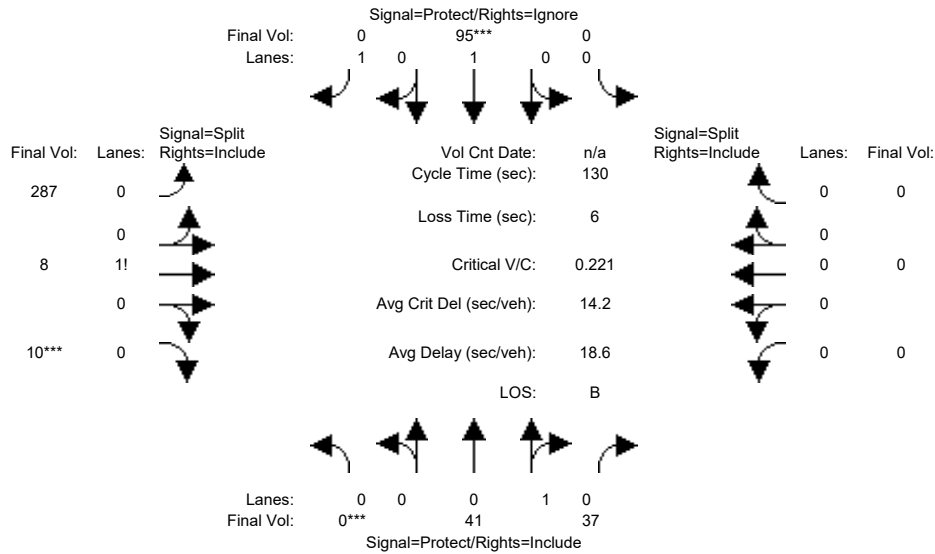

Street Name:	Grant Line Road						I-580 EB Offramp					
Approach:	North Bound			South Bound			East Bound			West Bound		
Movement:	L	T	R	L	T	R	L	T	R	L	T	R
Min. Green:	10	10	10	10	10	10	10	10	10	0	0	0
Y+R:	4.0	4.0	4.0	4.0	4.0	4.0	4.0	4.0	4.0	4.0	4.0	4.0

Volume Module:	North Bound			South Bound			East Bound			West Bound		
Base Vol:	0	41	37	0	95	112	287	8	10	0	0	0
Growth Adj:	1.00	1.00	1.00	1.00	1.00	1.00	1.00	1.00	1.00	1.00	1.00	1.00
Initial Bse:	0	41	37	0	95	112	287	8	10	0	0	0
Added Vol:	0	0	0	0	0	0	0	0	0	0	0	0
PasserByVol:	0	0	0	0	0	0	0	0	0	0	0	0
Initial Fut:	0	41	37	0	95	112	287	8	10	0	0	0
User Adj:	1.00	1.00	1.00	1.00	1.00	0.00	1.00	1.00	1.00	1.00	1.00	1.00
PHF Adj:	1.00	1.00	1.00	1.00	1.00	0.00	1.00	1.00	1.00	1.00	1.00	1.00
PHF Volume:	0	41	37	0	95	0	287	8	10	0	0	0
Reduct Vol:	0	0	0	0	0	0	0	0	0	0	0	0
Reduced Vol:	0	41	37	0	95	0	287	8	10	0	0	0
PCE Adj:	1.00	1.00	1.00	1.00	1.00	0.00	1.00	1.00	1.00	1.00	1.00	1.00
MLF Adj:	1.00	1.00	1.00	1.00	1.00	0.00	1.00	1.00	1.00	1.00	1.00	1.00
FinalVolume:	0	41	37	0	95	0	287	8	10	0	0	0

Saturation Flow Module:	North Bound			South Bound			East Bound			West Bound		
Sat/Lane:	1900	1900	1900	1900	1900	1900	1900	1900	1900	1900	1900	1900
Adjustment:	1.00	1.00	1.00	1.00	1.00	1.00	1.00	1.00	1.00	1.00	1.00	1.00
Lanes:	0.00	0.53	0.47	0.00	1.00	1.00	0.94	0.03	0.03	0.00	0.00	0.00
Final Sat.:	0	999	901	0	1900	1900	1788	50	62	0	0	0

Capacity Analysis Module:	North Bound			South Bound			East Bound			West Bound		
Vol/Sat:	0.00	0.04	0.04	0.00	0.05	0.00	0.16	0.16	0.16	0.00	0.00	0.00
Crit Moves:	****			****			****					
Green Time:	0.0	29.4	29.4	0.0	29.4	0.0	94.6	94.6	94.6	0.0	0.0	0.0
Volume/Cap:	0.00	0.18	0.18	0.00	0.22	0.00	0.22	0.22	0.22	0.00	0.00	0.00
Delay/Veh:	0.0	40.8	40.8	0.0	41.2	0.0	5.8	5.8	5.8	0.0	0.0	0.0
User DelAdj:	1.00	1.00	1.00	1.00	1.00	1.00	1.00	1.00	1.00	1.00	1.00	1.00
AdjDel/Veh:	0.0	40.8	40.8	0.0	41.2	0.0	5.8	5.8	5.8	0.0	0.0	0.0
LOS by Move:	A	D	D	A	D	A	A	A	A	A	A	A
HCM2k95thQ:	0	5	5	0	6	0	8	8	8	0	0	0

Note: Queue reported is the number of cars per lane.

Jess Ranch

Level Of Service Computation Report
2000 HCM Operations (Future Volume Alternative)
Cumulative PM Baseline

Intersection #1: Grant Line Rd and I-580 EB

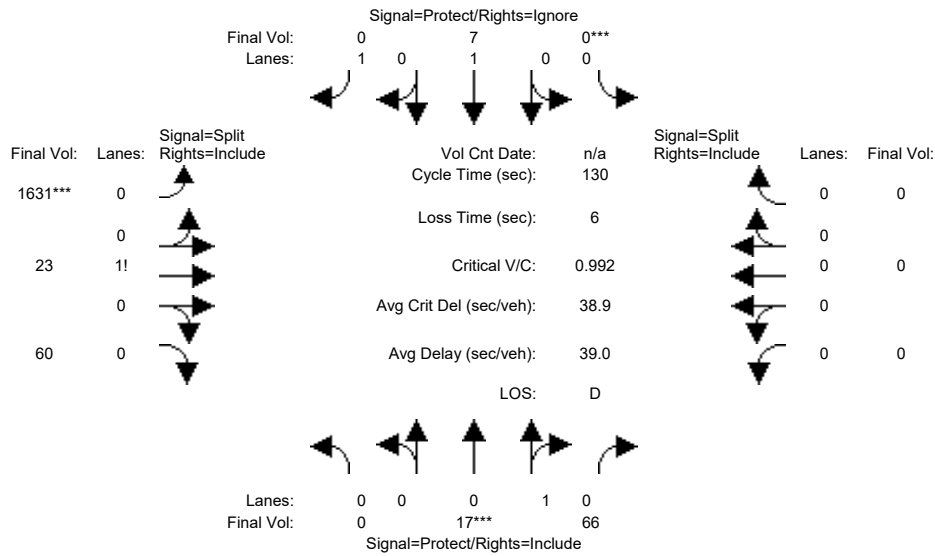

Street Name:	Grant Line Road						I-580 EB Offramp					
Approach:	North Bound			South Bound			East Bound			West Bound		
Movement:	L	T	R	L	T	R	L	T	R	L	T	R
Min. Green:	10	10	10	10	10	10	10	10	10	0	0	0
Y+R:	4.0	4.0	4.0	4.0	4.0	4.0	4.0	4.0	4.0	4.0	4.0	4.0

Volume Module:												
Base Vol:	0	17	66	0	7	518	1631	23	60	0	0	0
Growth Adj:	1.00	1.00	1.00	1.00	1.00	1.00	1.00	1.00	1.00	1.00	1.00	1.00
Initial Bse:	0	17	66	0	7	518	1631	23	60	0	0	0
Added Vol:	0	0	0	0	0	0	0	0	0	0	0	0
PasserByVol:	0	0	0	0	0	0	0	0	0	0	0	0
Initial Fut:	0	17	66	0	7	518	1631	23	60	0	0	0
User Adj:	1.00	1.00	1.00	1.00	1.00	0.00	1.00	1.00	1.00	1.00	1.00	1.00
PHF Adj:	1.00	1.00	1.00	1.00	1.00	0.00	1.00	1.00	1.00	1.00	1.00	1.00
PHF Volume:	0	17	66	0	7	0	1631	23	60	0	0	0
Reduct Vol:	0	0	0	0	0	0	0	0	0	0	0	0
Reduced Vol:	0	17	66	0	7	0	1631	23	60	0	0	0
PCE Adj:	1.00	1.00	1.00	1.00	1.00	0.00	1.00	1.00	1.00	1.00	1.00	1.00
MLF Adj:	1.00	1.00	1.00	1.00	1.00	0.00	1.00	1.00	1.00	1.00	1.00	1.00
Final Volume:	0	17	66	0	7	0	1631	23	60	0	0	0

Saturation Flow Module:												
Sat/Lane:	1900	1900	1900	1900	1900	1900	1900	1900	1900	1900	1900	1900
Adjustment:	1.00	1.00	1.00	1.00	1.00	1.00	1.00	1.00	1.00	1.00	1.00	1.00
Lanes:	0.00	0.20	0.80	0.00	1.00	1.00	0.95	0.01	0.04	0.00	0.00	0.00
Final Sat.:	0	389	1511	0	1900	1900	1808	25	67	0	0	0

Capacity Analysis Module:												
Vol/Sat:	0.00	0.04	0.04	0.00	0.00	0.00	0.90	0.90	0.90	0.00	0.00	0.00
Crit Moves:	****			****			****					
Green Time:	0.0	10.0	10.0	0.0	10.0	0.0	114.0	114	114.0	0.0	0.0	0.0
Volume/Cap:	0.00	0.57	0.57	0.00	0.05	0.00	1.03	1.03	1.03	0.00	0.00	0.00
Delay/Veh:	0.0	63.1	63.1	0.0	55.7	0.0	37.7	37.7	37.7	0.0	0.0	0.0
User DelAdj:	1.00	1.00	1.00	1.00	1.00	1.00	1.00	1.00	1.00	1.00	1.00	1.00
AdjDel/Veh:	0.0	63.1	63.1	0.0	55.7	0.0	37.7	37.7	37.7	0.0	0.0	0.0
LOS by Move:	A	E	E	A	E	A	D	D	D	A	A	A
HCM2k95thQ:	0	8	8	0	1	0	120	120	120	0	0	0

Note: Queue reported is the number of cars per lane.

Jess Ranch

Level Of Service Computation Report
2000 HCM Operations (Future Volume Alternative)
Cumulative AM w/Project

Intersection #1: Grant Line Rd and I-580 EB

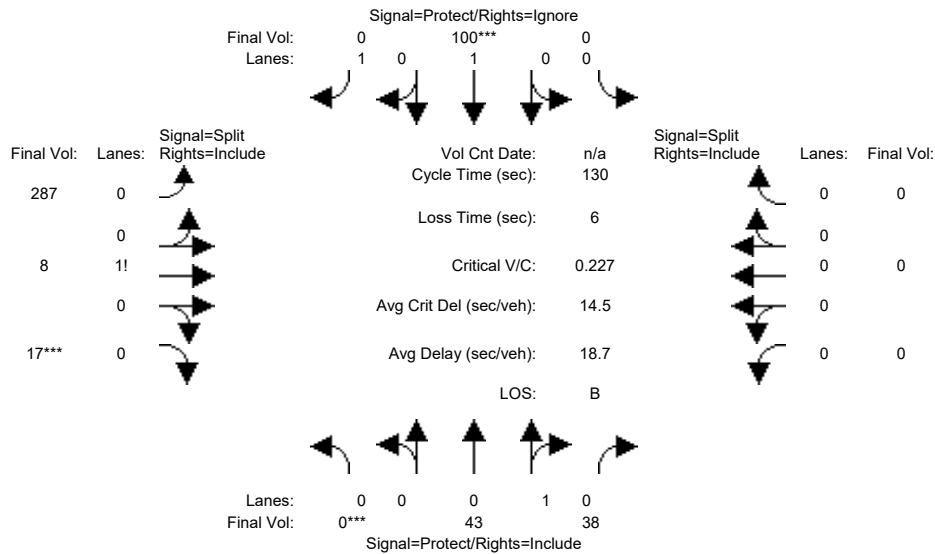

Street Name:	Grant Line Road						I-580 EB Offramp					
Approach:	North Bound			South Bound			East Bound			West Bound		
Movement:	L	T	R	L	T	R	L	T	R	L	T	R
Min. Green:	10	10	10	10	10	10	10	10	10	0	0	0
Y+R:	4.0	4.0	4.0	4.0	4.0	4.0	4.0	4.0	4.0	4.0	4.0	4.0

Volume Module:	North Bound			South Bound			East Bound			West Bound		
Base Vol:	0	43	38	0	100	112	287	8	17	0	0	0
Growth Adj:	1.00	1.00	1.00	1.00	1.00	1.00	1.00	1.00	1.00	1.00	1.00	1.00
Initial Bse:	0	43	38	0	100	112	287	8	17	0	0	0
Added Vol:	0	0	0	0	0	0	0	0	0	0	0	0
PasserByVol:	0	0	0	0	0	0	0	0	0	0	0	0
Initial Fut:	0	43	38	0	100	112	287	8	17	0	0	0
User Adj:	1.00	1.00	1.00	1.00	1.00	0.00	1.00	1.00	1.00	1.00	1.00	1.00
PHF Adj:	1.00	1.00	1.00	1.00	1.00	0.00	1.00	1.00	1.00	1.00	1.00	1.00
PHF Volume:	0	43	38	0	100	0	287	8	17	0	0	0
Reduct Vol:	0	0	0	0	0	0	0	0	0	0	0	0
Reduced Vol:	0	43	38	0	100	0	287	8	17	0	0	0
PCE Adj:	1.00	1.00	1.00	1.00	1.00	0.00	1.00	1.00	1.00	1.00	1.00	1.00
MLF Adj:	1.00	1.00	1.00	1.00	1.00	0.00	1.00	1.00	1.00	1.00	1.00	1.00
Final Volume:	0	43	38	0	100	0	287	8	17	0	0	0

Saturation Flow Module:	North Bound			South Bound			East Bound			West Bound		
Sat/Lane:	1900	1900	1900	1900	1900	1900	1900	1900	1900	1900	1900	1900
Adjustment:	1.00	1.00	1.00	1.00	1.00	1.00	1.00	1.00	1.00	1.00	1.00	1.00
Lanes:	0.00	0.53	0.47	0.00	1.00	1.00	0.92	0.03	0.05	0.00	0.00	0.00
Final Sat.:	0	1009	891	0	1900	1900	1748	49	104	0	0	0

Capacity Analysis Module:	North Bound			South Bound			East Bound			West Bound		
Vol/Sat:	0.00	0.04	0.04	0.00	0.05	0.00	0.16	0.16	0.16	0.00	0.00	0.00
Crit Moves:	***			***			***					
Green Time:	0.0	30.1	30.1	0.0	30.1	0.0	93.9	93.9	93.9	0.0	0.0	0.0
Volume/Cap:	0.00	0.18	0.18	0.00	0.23	0.00	0.23	0.23	0.23	0.00	0.00	0.00
Delay/Veh:	0.0	40.3	40.3	0.0	40.8	0.0	6.1	6.1	6.1	0.0	0.0	0.0
User DelAdj:	1.00	1.00	1.00	1.00	1.00	1.00	1.00	1.00	1.00	1.00	1.00	1.00
AdjDel/Veh:	0.0	40.3	40.3	0.0	40.8	0.0	6.1	6.1	6.1	0.0	0.0	0.0
LOS by Move:	A	D	D	A	D	A	A	A	A	A	A	A
HCM2k95thQ:	0	5	5	0	6	0	8	8	8	0	0	0

Note: Queue reported is the number of cars per lane.

Jess Ranch

Level Of Service Computation Report
2000 HCM Operations (Future Volume Alternative)
Cumulative PM w/Project

Intersection #1: Grant Line Rd and I-580 EB

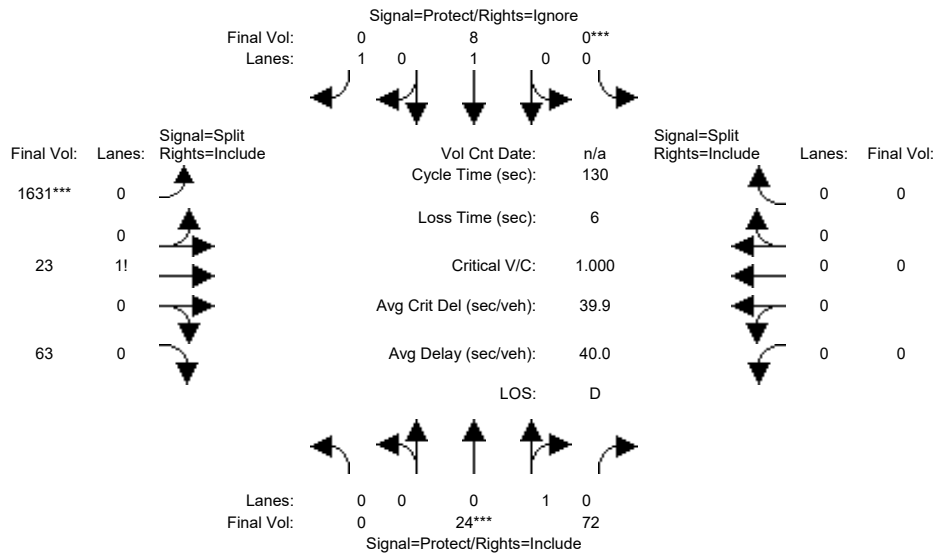

Street Name:	Grant Line Road						I-580 EB Offramp					
Approach:	North Bound			South Bound			East Bound			West Bound		
Movement:	L	T	R	L	T	R	L	T	R	L	T	R
Min. Green:	10	10	10	10	10	10	10	10	10	0	0	0
Y+R:	4.0	4.0	4.0	4.0	4.0	4.0	4.0	4.0	4.0	4.0	4.0	4.0

Volume Module:												
Base Vol:	0	24	72	0	8	518	1631	23	63	0	0	0
Growth Adj:	1.00	1.00	1.00	1.00	1.00	1.00	1.00	1.00	1.00	1.00	1.00	1.00
Initial Bse:	0	24	72	0	8	518	1631	23	63	0	0	0
Added Vol:	0	0	0	0	0	0	0	0	0	0	0	0
PasserByVol:	0	0	0	0	0	0	0	0	0	0	0	0
Initial Fut:	0	24	72	0	8	518	1631	23	63	0	0	0
User Adj:	1.00	1.00	1.00	1.00	1.00	0.00	1.00	1.00	1.00	1.00	1.00	1.00
PHF Adj:	1.00	1.00	1.00	1.00	1.00	0.00	1.00	1.00	1.00	1.00	1.00	1.00
PHF Volume:	0	24	72	0	8	0	1631	23	63	0	0	0
Reduct Vol:	0	0	0	0	0	0	0	0	0	0	0	0
Reduced Vol:	0	24	72	0	8	0	1631	23	63	0	0	0
PCE Adj:	1.00	1.00	1.00	1.00	1.00	0.00	1.00	1.00	1.00	1.00	1.00	1.00
MLF Adj:	1.00	1.00	1.00	1.00	1.00	0.00	1.00	1.00	1.00	1.00	1.00	1.00
Final Volume:	0	24	72	0	8	0	1631	23	63	0	0	0

Saturation Flow Module:												
Sat/Lane:	1900	1900	1900	1900	1900	1900	1900	1900	1900	1900	1900	1900
Adjustment:	1.00	1.00	1.00	1.00	1.00	1.00	1.00	1.00	1.00	1.00	1.00	1.00
Lanes:	0.00	0.25	0.75	0.00	1.00	1.00	0.95	0.01	0.04	0.00	0.00	0.00
Final Sat.:	0	475	1425	0	1900	1900	1805	25	70	0	0	0

Capacity Analysis Module:												
Vol/Sat:	0.00	0.05	0.05	0.00	0.00	0.00	0.90	0.90	0.90	0.00	0.00	0.00
Crit Moves:	****			****			****					
Green Time:	0.0	10.0	10.0	0.0	10.0	0.0	114.0	114	114.0	0.0	0.0	0.0
Volume/Cap:	0.00	0.66	0.66	0.00	0.05	0.00	1.03	1.03	1.03	0.00	0.00	0.00
Delay/Veh:	0.0	68.7	68.7	0.0	55.8	0.0	38.3	38.3	38.3	0.0	0.0	0.0
User DelAdj:	1.00	1.00	1.00	1.00	1.00	1.00	1.00	1.00	1.00	1.00	1.00	1.00
AdjDel/Veh:	0.0	68.7	68.7	0.0	55.8	0.0	38.3	38.3	38.3	0.0	0.0	0.0
LOS by Move:	A	E	E	A	E	A	D	D	D	A	A	A
HCM2k95thQ:	0	10	10	0	1	0	121	121	121	0	0	0

Note: Queue reported is the number of cars per lane.

Jess Ranch

Level Of Service Computation Report
2000 HCM Operations (Future Volume Alternative)
Cumulative AM Baseline

Intersection #2: Grant Line Rd and I-580 WB

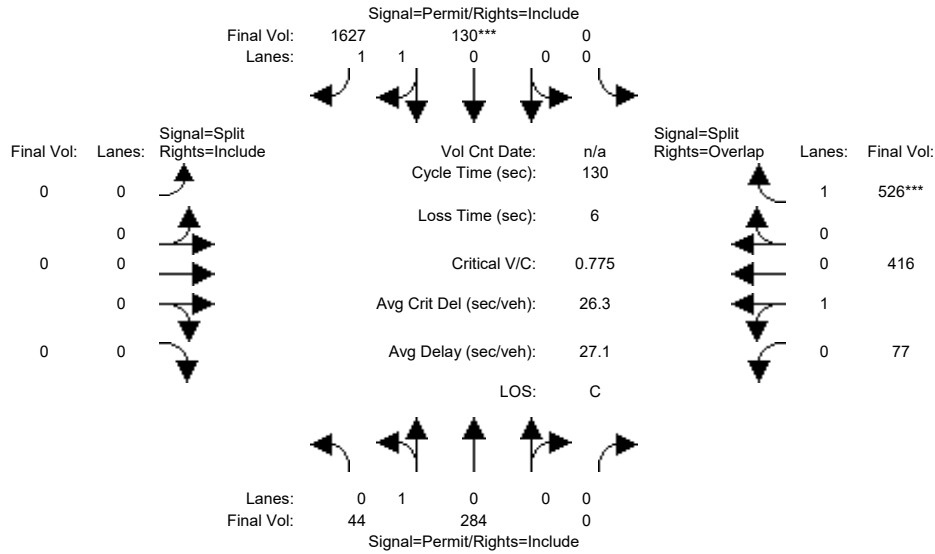

Street Name:	Grant Line Road						I-580 WB Offramp					
Approach:	North Bound			South Bound			East Bound			West Bound		
Movement:	L	T	R	L	T	R	L	T	R	L	T	R
Min. Green:	10	10	10	10	10	10	0	0	0	10	10	10
Y+R:	4.0	4.0	4.0	4.0	4.0	4.0	4.0	4.0	4.0	4.0	4.0	4.0

Volume Module:	North Bound			South Bound			East Bound			West Bound		
Base Vol:	44	284	0	0	130	1627	0	0	0	77	416	526
Growth Adj:	1.00	1.00	1.00	1.00	1.00	1.00	1.00	1.00	1.00	1.00	1.00	1.00
Initial Bse:	44	284	0	0	130	1627	0	0	0	77	416	526
Added Vol:	0	0	0	0	0	0	0	0	0	0	0	0
PasserByVol:	0	0	0	0	0	0	0	0	0	0	0	0
Initial Fut:	44	284	0	0	130	1627	0	0	0	77	416	526
User Adj:	1.00	1.00	1.00	1.00	1.00	1.00	1.00	1.00	1.00	1.00	1.00	1.00
PHF Adj:	1.00	1.00	1.00	1.00	1.00	1.00	1.00	1.00	1.00	1.00	1.00	1.00
PHF Volume:	44	284	0	0	130	1627	0	0	0	77	416	526
Reduct Vol:	0	0	0	0	0	0	0	0	0	0	0	0
Reduced Vol:	44	284	0	0	130	1627	0	0	0	77	416	526
PCE Adj:	1.00	1.00	1.00	1.00	1.00	1.00	1.00	1.00	1.00	1.00	1.00	1.00
MLF Adj:	1.00	1.00	1.00	1.00	1.00	1.00	1.00	1.00	1.00	1.00	1.00	1.00
Final Volume:	44	284	0	0	130	1627	0	0	0	77	416	526

Saturation Flow Module:	North Bound			South Bound			East Bound			West Bound		
Sat/Lane:	1900	1900	1900	1900	1900	1900	1900	1900	1900	1900	1900	1900
Adjustment:	1.00	1.00	1.00	1.00	1.00	1.00	1.00	1.00	1.00	1.00	1.00	1.00
Lanes:	0.13	0.87	0.00	0.00	0.15	1.85	0.00	0.00	0.00	0.16	0.84	1.00
Final Sat.:	255	1645	0	0	281	3519	0	0	0	297	1603	1900

Capacity Analysis Module:	North Bound			South Bound			East Bound			West Bound		
Vol/Sat:	0.17	0.17	0.00	0.00	0.46	0.46	0.00	0.00	0.00	0.26	0.26	0.28
Crit Moves:					****							****
Green Time:	77.6	77.6	0.0	0.0	77.6	77.6	0.0	0.0	0.0	46.4	46.4	46.4
Volume/Cap:	0.29	0.29	0.00	0.00	0.77	0.77	0.00	0.00	0.00	0.73	0.73	0.77
Delay/Veh:	12.9	12.9	0.0	0.0	21.4	21.4	0.0	0.0	0.0	40.2	40.2	42.7
User DelAdj:	1.00	1.00	1.00	1.00	1.00	1.00	1.00	1.00	1.00	1.00	1.00	1.00
AdjDel/Veh:	12.9	12.9	0.0	0.0	21.4	21.4	0.0	0.0	0.0	40.2	40.2	42.7
LOS by Move:	B	B	A	A	C	C	A	A	A	D	D	D
HCM2k95thQ:	12	12	0	0	44	44	0	0	0	31	31	34

Note: Queue reported is the number of cars per lane.

Jess Ranch

Level Of Service Computation Report
2000 HCM Operations (Future Volume Alternative)
Cumulative PM Baseline

Intersection #2: Grant Line Rd and I-580 WB

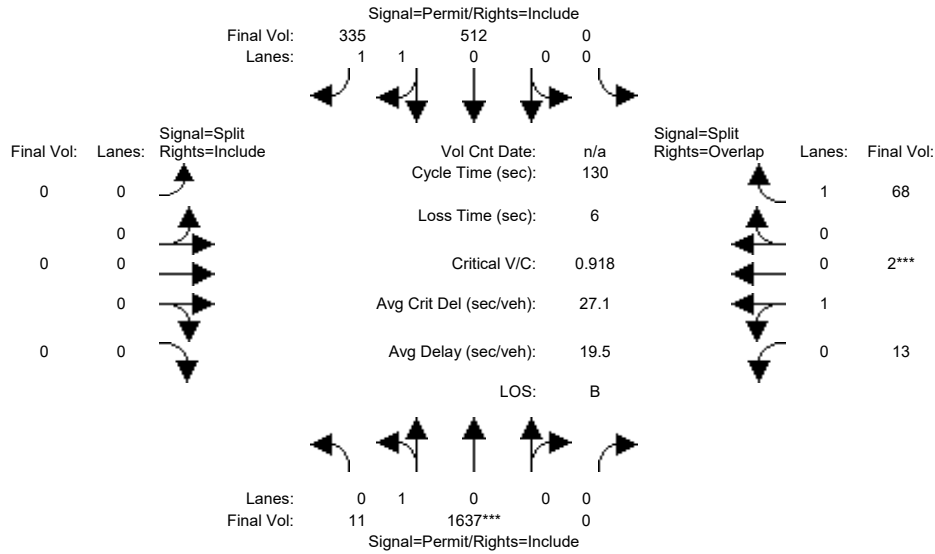

Street Name:	Grant Line Road						I-580 WB Offramp					
Approach:	North Bound			South Bound			East Bound			West Bound		
Movement:	L	T	R	L	T	R	L	T	R	L	T	R
Min. Green:	10	10	10	10	10	10	0	0	0	10	10	10
Y+R:	4.0	4.0	4.0	4.0	4.0	4.0	4.0	4.0	4.0	4.0	4.0	4.0

Volume Module:	North Bound			South Bound			East Bound			West Bound			
Base Vol:	11	1637	0	0	0	512	335	0	0	0	13	2	68
Growth Adj:	1.00	1.00	1.00	1.00	1.00	1.00	1.00	1.00	1.00	1.00	1.00	1.00	
Initial Bse:	11	1637	0	0	0	512	335	0	0	0	13	2	68
Added Vol:	0	0	0	0	0	0	0	0	0	0	0	0	0
PasserByVol:	0	0	0	0	0	0	0	0	0	0	0	0	0
Initial Fut:	11	1637	0	0	0	512	335	0	0	0	13	2	68
User Adj:	1.00	1.00	1.00	1.00	1.00	1.00	1.00	1.00	1.00	1.00	1.00	1.00	
PHF Adj:	1.00	1.00	1.00	1.00	1.00	1.00	1.00	1.00	1.00	1.00	1.00	1.00	
PHF Volume:	11	1637	0	0	0	512	335	0	0	0	13	2	68
Reduct Vol:	0	0	0	0	0	0	0	0	0	0	0	0	0
Reduced Vol:	11	1637	0	0	0	512	335	0	0	0	13	2	68
PCE Adj:	1.00	1.00	1.00	1.00	1.00	1.00	1.00	1.00	1.00	1.00	1.00	1.00	
MLF Adj:	1.00	1.00	1.00	1.00	1.00	1.00	1.00	1.00	1.00	1.00	1.00	1.00	
Final Volume:	11	1637	0	0	0	512	335	0	0	0	13	2	68

Saturation Flow Module:	North Bound			South Bound			East Bound			West Bound		
Sat/Lane:	1900	1900	1900	1900	1900	1900	1900	1900	1900	1900	1900	1900
Adjustment:	1.00	1.00	1.00	1.00	1.00	1.00	1.00	1.00	1.00	1.00	1.00	1.00
Lanes:	0.01	0.99	0.00	0.00	1.00	1.00	0.00	0.00	0.00	0.87	0.13	1.00
Final Sat.:	13	1887	0	0	1900	1900	0	0	0	1647	253	1900

Capacity Analysis Module:	North Bound			South Bound			East Bound			West Bound		
Vol/Sat:	0.87	0.87	0.00	0.00	0.27	0.18	0.00	0.00	0.00	0.01	0.01	0.04
Crit Moves:	****									****		
Green Time:	114.0	114	0.0	0.0	114	114.0	0.0	0.0	0.0	10.0	10.0	10.0
Volume/Cap:	0.99	0.99	0.00	0.00	0.31	0.20	0.00	0.00	0.00	0.10	0.10	0.47
Delay/Veh:	26.8	26.8	0.0	0.0	1.4	1.2	0.0	0.0	0.0	56.1	56.1	59.8
User DelAdj:	1.00	1.00	1.00	1.00	1.00	1.00	1.00	1.00	1.00	1.00	1.00	1.00
AdjDel/Veh:	26.8	26.8	0.0	0.0	1.4	1.2	0.0	0.0	0.0	56.1	56.1	59.8
LOS by Move:	C	C	A	A	A	A	A	A	A	E	E	E
HCM2k95thQ:	104	104	0	0	7	4	0	0	0	1	1	6

Note: Queue reported is the number of cars per lane.

Jess Ranch

Level Of Service Computation Report
2000 HCM Operations (Future Volume Alternative)
Cumulative AM w/Project

Intersection #2: Grant Line Rd and I-580 WB

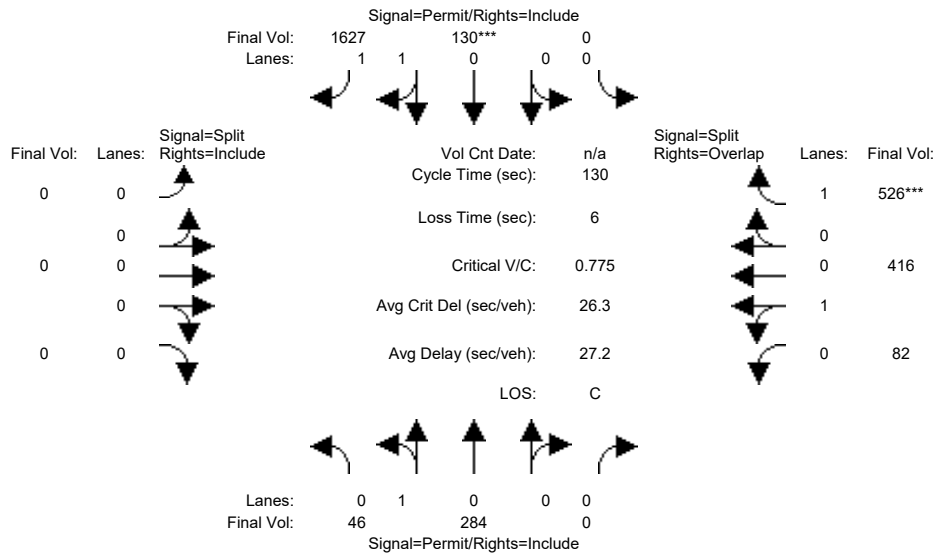

Street Name:	Grant Line Road						I-580 WB Offramp					
Approach:	North Bound			South Bound			East Bound			West Bound		
Movement:	L	T	R	L	T	R	L	T	R	L	T	R
Min. Green:	10	10	10	10	10	10	0	0	0	10	10	10
Y+R:	4.0	4.0	4.0	4.0	4.0	4.0	4.0	4.0	4.0	4.0	4.0	4.0

Volume Module:	North Bound			South Bound			East Bound			West Bound		
Base Vol:	46	284	0	0	130	1627	0	0	0	82	416	526
Growth Adj:	1.00	1.00	1.00	1.00	1.00	1.00	1.00	1.00	1.00	1.00	1.00	1.00
Initial Bse:	46	284	0	0	130	1627	0	0	0	82	416	526
Added Vol:	0	0	0	0	0	0	0	0	0	0	0	0
PasserByVol:	0	0	0	0	0	0	0	0	0	0	0	0
Initial Fut:	46	284	0	0	130	1627	0	0	0	82	416	526
User Adj:	1.00	1.00	1.00	1.00	1.00	1.00	1.00	1.00	1.00	1.00	1.00	1.00
PHF Adj:	1.00	1.00	1.00	1.00	1.00	1.00	1.00	1.00	1.00	1.00	1.00	1.00
PHF Volume:	46	284	0	0	130	1627	0	0	0	82	416	526
Reduct Vol:	0	0	0	0	0	0	0	0	0	0	0	0
Reduced Vol:	46	284	0	0	130	1627	0	0	0	82	416	526
PCE Adj:	1.00	1.00	1.00	1.00	1.00	1.00	1.00	1.00	1.00	1.00	1.00	1.00
MLF Adj:	1.00	1.00	1.00	1.00	1.00	1.00	1.00	1.00	1.00	1.00	1.00	1.00
Final Volume:	46	284	0	0	130	1627	0	0	0	82	416	526

Saturation Flow Module:	North Bound			South Bound			East Bound			West Bound		
Sat/Lane:	1900	1900	1900	1900	1900	1900	1900	1900	1900	1900	1900	1900
Adjustment:	1.00	1.00	1.00	1.00	1.00	1.00	1.00	1.00	1.00	1.00	1.00	1.00
Lanes:	0.14	0.86	0.00	0.00	0.15	1.85	0.00	0.00	0.00	0.16	0.84	1.00
Final Sat.:	265	1635	0	0	281	3519	0	0	0	313	1587	1900

Capacity Analysis Module:	North Bound			South Bound			East Bound			West Bound		
Vol/Sat:	0.17	0.17	0.00	0.00	0.46	0.46	0.00	0.00	0.00	0.26	0.26	0.28
Crit Moves:					****							****
Green Time:	77.6	77.6	0.0	0.0	77.6	77.6	0.0	0.0	0.0	46.4	46.4	46.4
Volume/Cap:	0.29	0.29	0.00	0.00	0.77	0.77	0.00	0.00	0.00	0.73	0.73	0.77
Delay/Veh:	12.9	12.9	0.0	0.0	21.4	21.4	0.0	0.0	0.0	40.5	40.5	42.7
User DelAdj:	1.00	1.00	1.00	1.00	1.00	1.00	1.00	1.00	1.00	1.00	1.00	1.00
AdjDel/Veh:	12.9	12.9	0.0	0.0	21.4	21.4	0.0	0.0	0.0	40.5	40.5	42.7
LOS by Move:	B	B	A	A	C	C	A	A	A	D	D	D
HCM2k95thQ:	12	12	0	0	44	44	0	0	0	31	31	34

Note: Queue reported is the number of cars per lane.

Jess Ranch

Level Of Service Computation Report
2000 HCM Operations (Future Volume Alternative)
Cumulative PM w/Project

Intersection #2: Grant Line Rd and I-580 WB

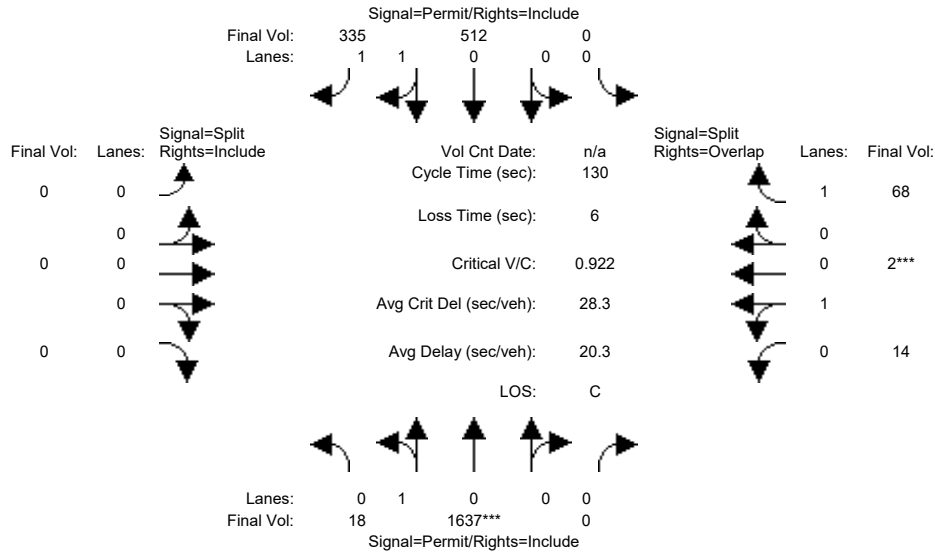

Street Name:	Grant Line Road						I-580 WB Offramp					
Approach:	North Bound			South Bound			East Bound			West Bound		
Movement:	L	T	R	L	T	R	L	T	R	L	T	R
Min. Green:	10	10	10	10	10	10	0	0	0	10	10	10
Y+R:	4.0	4.0	4.0	4.0	4.0	4.0	4.0	4.0	4.0	4.0	4.0	4.0

Volume Module:	North Bound			South Bound			East Bound			West Bound			
Base Vol:	18	1637	0	0	0	512	335	0	0	0	14	2	68
Growth Adj:	1.00	1.00	1.00	1.00	1.00	1.00	1.00	1.00	1.00	1.00	1.00	1.00	1.00
Initial Bse:	18	1637	0	0	0	512	335	0	0	0	14	2	68
Added Vol:	0	0	0	0	0	0	0	0	0	0	0	0	0
PasserByVol:	0	0	0	0	0	0	0	0	0	0	0	0	0
Initial Fut:	18	1637	0	0	0	512	335	0	0	0	14	2	68
User Adj:	1.00	1.00	1.00	1.00	1.00	1.00	1.00	1.00	1.00	1.00	1.00	1.00	1.00
PHF Adj:	1.00	1.00	1.00	1.00	1.00	1.00	1.00	1.00	1.00	1.00	1.00	1.00	1.00
PHF Volume:	18	1637	0	0	0	512	335	0	0	0	14	2	68
Reduct Vol:	0	0	0	0	0	0	0	0	0	0	0	0	0
Reduced Vol:	18	1637	0	0	0	512	335	0	0	0	14	2	68
PCE Adj:	1.00	1.00	1.00	1.00	1.00	1.00	1.00	1.00	1.00	1.00	1.00	1.00	1.00
MLF Adj:	1.00	1.00	1.00	1.00	1.00	1.00	1.00	1.00	1.00	1.00	1.00	1.00	1.00
Final Volume:	18	1637	0	0	0	512	335	0	0	0	14	2	68

Saturation Flow Module:	North Bound			South Bound			East Bound			West Bound		
Sat/Lane:	1900	1900	1900	1900	1900	1900	1900	1900	1900	1900	1900	1900
Adjustment:	1.00	1.00	1.00	1.00	1.00	1.00	1.00	1.00	1.00	1.00	1.00	1.00
Lanes:	0.01	0.99	0.00	0.00	1.00	1.00	0.00	0.00	0.00	0.87	0.13	1.00
Final Sat.:	21	1879	0	0	1900	1900	0	0	0	1663	238	1900

Capacity Analysis Module:	North Bound			South Bound			East Bound			West Bound		
Vol/Sat:	0.87	0.87	0.00	0.00	0.27	0.18	0.00	0.00	0.00	0.01	0.01	0.04
Crit Moves:	****									****		
Green Time:	114.0	114	0.0	0.0	114	114.0	0.0	0.0	0.0	10.0	10.0	10.0
Volume/Cap:	0.99	0.99	0.00	0.00	0.31	0.20	0.00	0.00	0.00	0.11	0.11	0.47
Delay/Veh:	28.0	28.0	0.0	0.0	1.4	1.2	0.0	0.0	0.0	56.2	56.2	59.8
User DelAdj:	1.00	1.00	1.00	1.00	1.00	1.00	1.00	1.00	1.00	1.00	1.00	1.00
AdjDel/Veh:	28.0	28.0	0.0	0.0	1.4	1.2	0.0	0.0	0.0	56.2	56.2	59.8
LOS by Move:	C	C	A	A	A	A	A	A	A	E	E	E
HCM2k95thQ:	107	107	0	0	7	4	0	0	0	1	1	6

Note: Queue reported is the number of cars per lane.

Appendix C

Signal Warrant Analysis

Grant Line Road and I-580 WB Ramps

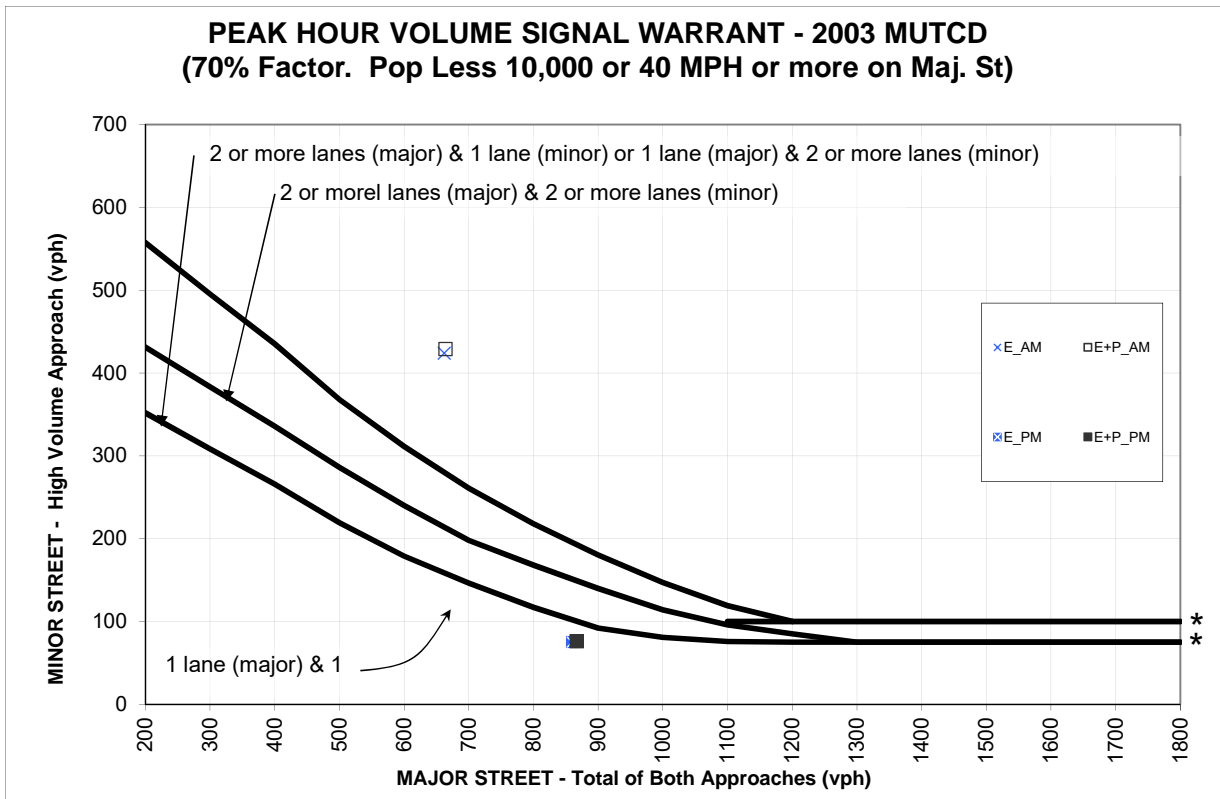

* NOTE: 100 vph applies as the lower threshold volume for a minor street approach with 2 or more lanes and 75 vph applies as the lower threshold volume for a minor street approach with 1 lane.

Peak Hour Volume Warrant Per 2003 MUTCD - Over 40 MPH

		Approach Lanes		AM Peak Hour Volumes			
		2 or One More		<i>E_AM</i>	<i>E+P_AM</i>		
Major Street - Both Approaches	Grant Line Road	x		662	664		
Minor Street - Highest Approach	I-580 WB Off-Ramp	x		424	429		
Warrant Met?				yes	yes		

		Approach Lanes		<i>E_PM</i>	<i>E+P_PM</i>		
		2 or One More					
Major Street - Both Approaches	Grant Line Road	x		860	867		
Minor Street - Highest Approach	I-580 WB Off-Ramp	x		75	76		
Warrant Met?				no	no		

Grant Line Road and I-580 EB Ramps

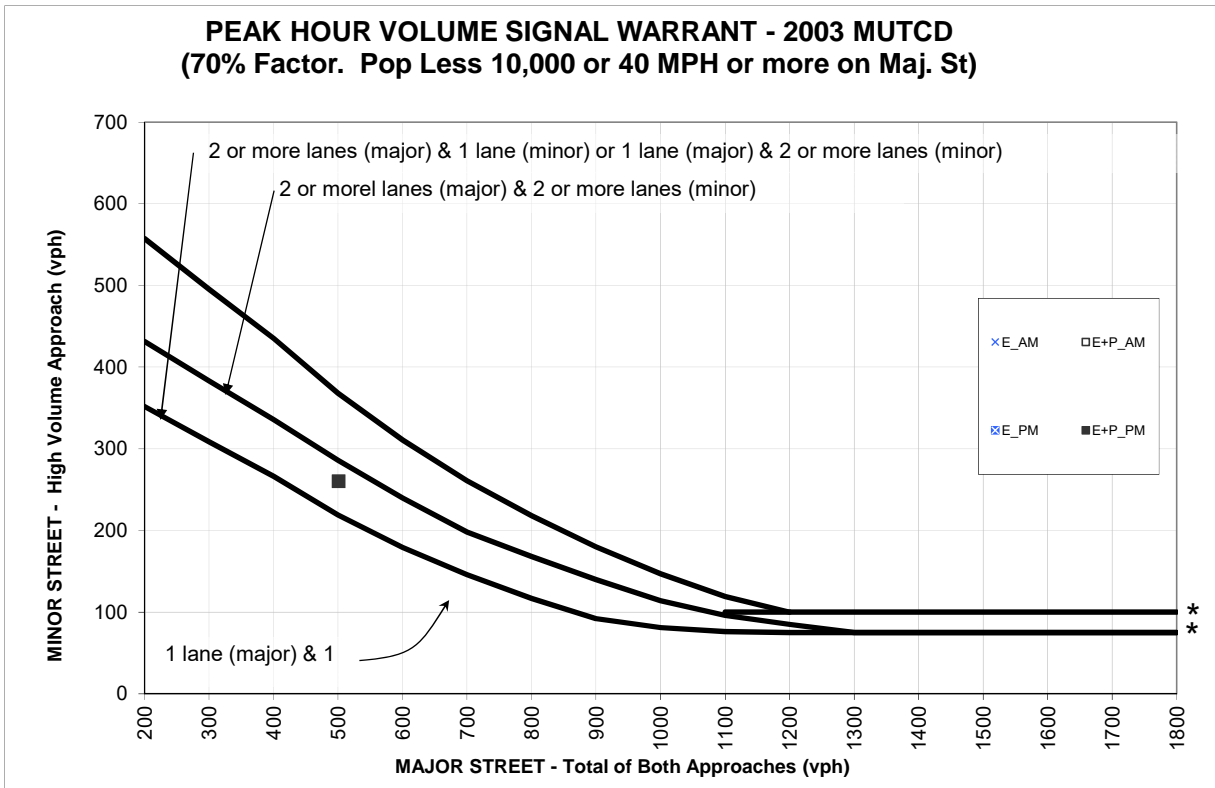

* NOTE: 100 vph applies as the lower threshold volume for a minor street approach with 2 or more lanes and 75 vph applies as the lower threshold volume for a minor street approach with 1 lane.

Peak Hour Volume Warrant Per 2003 MUTCD - Over 40 MPH

		Approach Lanes		AM Peak Hour Volumes			
		2 or One More		<i>E_AM</i>	<i>E+P_AM</i>		
Major Street - Both Approaches	Grant Line Road	x		56	61		
Minor Street - Highest Approach	I-580 EB Off-Ramp	x		82	89		
Warrant Met?				no	no		

		Approach Lanes		PM Peak Hour Volumes			
		2 or One More		<i>E_PM</i>	<i>E+P_PM</i>		
Major Street - Both Approaches	Grant Line Road	x		500	501		
Minor Street - Highest Approach	I-580 EB Off-Ramp	x		260	260		
Warrant Met?				yes	yes		